

TEAC®

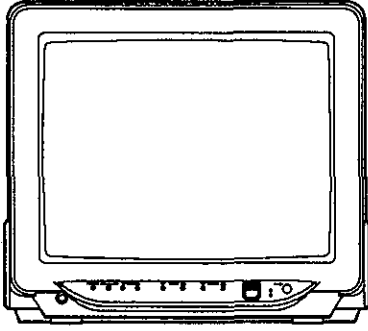

SERVICE MANUAL

CT-M144

14" COLOR TELEVISION

NOTES

- PC boards shown are viewed from parts side.
- Parts marked with * require longer delivery time.
- The parts with no reference number or no parts number in the exploded views are not supplied.
- As regards the resistors and capacitors, refer to the circuit diagrams contained in this manual.
- Parts marked with this sign are safety critical components. They must be replaced with identical components - refer to the appropriate parts list and ensure exact replacement.

TABLE OF CONTENTS

General Specifications	1-1	Electrical Parts List	8-1
Performance Specifications	2-1	Waveform Photographs	9-1
Important Safety Precautions	3-1	Voltage Charts	10-1
Disassembly Instructions	4-1	Wiring Diagram	11-1
Electrical Adjustment Instructions	5-1	Cabinet Exploded View	12-1
Block Diagram	6-1	Cabinet Parts List	13-1
Schematic Diagram / P.C.B. and Test Points	7-1	Packing Exploded View	14-1
		Included Accessories & Packing Parts List	15-1

GENERAL SPECIFICATIONS *

FEATURE and SPECIFICATIONS

Color System:	PAL - B/G
Tuning System:	Voltage Synthesizer
Receivable Channels:	VHF-L; 0~5 ch
- Australia ch -	VHF-H; 5A~11 ch
(NZ ch available)	UHF; 21~69 ch (can be memory 50 station)
Antenna Impedance:	UHF/VHF 75Ω, Unbalanced
Picture Tube:	14"
Picture Control:	Color, Brightness, (Remote) Contrast and, Video mode (Sharp/Soft)
Picture Control Memory:	Standard - Select (Remote)
Speaker:	3" (77mm), Round Type, 8Ω
Output Power:	1W, 10% THD
Other Features:	Automatic Channel Programming Automatic Degaussing
Power Source:	240V, 50Hz AC
Power Consumption:	70W
Cabinet Size:	364(W) x 355(D) x 317(H) mm (Approx)
Weight:	9Kg (Approx)
Regulations:	SAA

CONTROL and SWITCHES

Power:	Push (Front)
Channel Up/Down:	Push (Front)
Volume Up/Down:	Push (Front)
Tuning Up/Down:	Push (Front)
Program:	Push (Front)
Auto Memo/Band:	Push (Front)
Remote Control:	Standby (20keys)
	0/AV 1~9 Channel Up/Down Control& Volume Up/Down Picture Select (Bright/Contrast/ Color/Video Mode) Previous Mute Sleep Display

DISPLAY

LED Indicator:	LED (Red) * When turning on the power, the stand-by LED will turn off.
On Screen Display:	Channel Volume Brightness Color Contrast Sharp-Soft Sleep Timer (10~90 Minute) Tuning Indicator Band Position

ACCESSORIES

Remote Control Transmitter	
Battery:	R03 x 2
Owner's Manual	
Rod Antenna	

* Specifications are subject to change without notice.

PERFORMANCE SPECIFICATIONS

< Tuner >

ANT. Input ----- 75Ω Unbal., IEC connector
 Reference Level ----- 300mVp-p at Video Output
 Test Input Signal ----- 400Hz 30% modulation

<u>Description</u>	<u>Condition</u>	<u>Unit</u>	<u>Nominal</u>	<u>Limit</u>
1. Peak Picture Sens	VHF	dBμV	20	30
	UHF	dBμV	30	40
2. AFT Pull In Range (80dBμ input)	—	MHz	± 1.0	± 0.7
3. Intermediate Freq.	Picture	MHz	36.875	—
	Sound	MHz	31.375	—
4. Intercarrier Freq.	—	MHz	5.5	—

< Deflection >

<u>Description</u>	<u>Condition</u>	<u>Unit</u>	<u>Nominal</u>	<u>Limit</u>
1. Deflection Freq.	Horizontal	KHz	15.625	—
	Vertical	Hz	50	—
2. Linearity	Horizontal	%	—	± 15
	Vertical	%	—	± 15
3. High Voltage	—	KV	23	—

< Video & Chroma >

<u>Description</u>	<u>Condition</u>	<u>Unit</u>	<u>Nominal</u>	<u>Limit</u>
1. Misconvergence	Center	mm	—	0.4
	Side	mm	—	2.0
	Corner	mm	—	1.5
2. Over Scan	Horizontal	%	10	—
	Vertical	%	10	—
3. Color Temperature	—	K	8000K-10MPCD	—
4. Resolution	Horizontal	Line	300	—
	Vertical	Line	300	—
5. Brightness	APL 100%	Ft-L	45	35

<Audio>

All items are measured across 8Ω resistor at speaker output terminal.

<u>Description</u>	<u>Condition</u>	<u>Unit</u>	<u>Nominal</u>	<u>Limit</u>
1. Audio Output Power	10% THD	W	1.2	0.8
2. Audio Distortion	500mW	%	2	5
3. Audio Freq. Response	-6dB	Hz	—	100~6K

IMPORTANT SAFETY PRECAUTIONS

Prior to shipment from the factory, our products are strictly inspected for recognized product safety and electrical codes of the countries in which they are to be sold. However, in order to maintain such compliance, it is equally important to implement the following precautions when a set is being serviced.

Safety Precautions for TV Circuit

1. **Before returning an instrument to the customer, always make a safety check of the entire instrument, including, but not limited to, the following items:**

a. Be sure that no built-in protective devices are defective and have been defeated during servicing. (1) Protective shields are provided on this chassis to protect both the technician and the customer. Correctly replace all missing protective shields, including any removed for servicing convenience. (2) When reinstalling the chassis and/or other assembly in the cabinet, be sure to put back in place all protective devices, including but not limited to, nonmetallic control knobs, insulating fishpapers, adjustment and compartment covers/shields, and isolation resistor/capacitor networks. **Do not operate this instrument or permit it to be operated without all protective devices correctly installed and functioning. Servicers who defeat safety features or fail to perform safety checks may be liable for any resulting damage.**

b. Be sure that there are no cabinet openings through which an adult or child might be able to insert their fingers and contact a hazardous voltage. Such openings include, but are not limited to, (1) spacing between the picture tube and the cabinet mask, (2) excessively wide cabinet ventilation slots, and (3) an improperly fitted and/or incorrectly secured cabinet back cover.

c. **Antenna Cold Check** - With the instrument AC plug removed from any AC source, connect an electrical jumper across the two AC plug prongs. Place the instrument AC switch in the on position. Connect one lead of an ohmmeter to the AC plug prongs tied together and touch the other ohmmeter lead in turn to each tuner antenna input exposed terminal screw and, if applicable, to the coaxial connector. If the measured resistance is less than 1.0 megohm or greater than 5.2 megohm, an abnormality exists that must be corrected before the instrument is returned to the customer.

Repeat this test with the instrument AC switch in the off position.

d. **Leakage Current Hot Check** - With the instrument completely reassembled, plug the AC line cord directly into a AC outlet. (Do not use an isolation transformer during this test.) Use a leakage current tester. With the instrument AC switch first in the on position and then in the off position, measure from a known earth ground (metal water pipe, conduit, etc.) to all exposed metal parts of the instrument (antennas, handle brackets, metal cabinet, screw heads, metallic overlays, control shafts, etc.), especially any exposed metal parts that offer an electrical return path to the chassis. Any current measured must not exceed 0.5 milli-ampere. Reverse the instrument power cord plug in the outlet and repeat the test.

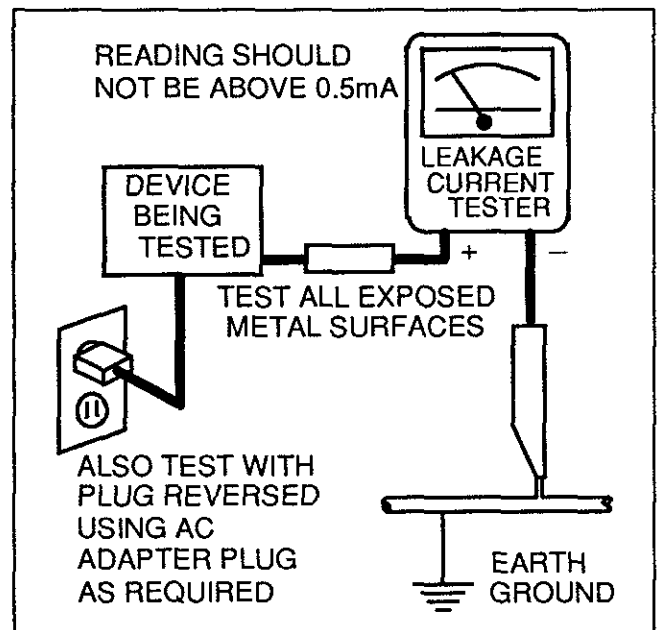

ANY MEASUREMENTS NOT WITHIN THE LIMITS SPECIFIED HEREIN INDICATE A POTENTIAL SHOCK HAZARD THAT MUST BE ELIMINATED BEFORE RETURNING THE INSTRUMENT TO THE CUSTOMER OR BEFORE CONNECTING THE ANTENNA OR ACCESSORIES.

e. X-Radiation and High Voltage Limits - Because the picture tube is the primary potential source of X-radiation in solid-state TV receivers, it is specially constructed to prohibit X-radiation emissions. For continued X-radiation protection, the replacement picture tube must be the same type as the original. Also, because the picture tube shields and mounting hardware perform an X-radiation protection function, they must be correctly in place. High voltage must be measured each time servicing is performed that involves B+, horizontal deflection or high voltage. Correct operation of the X-radiation protection circuits also must be reconfirmed each time they are serviced. (X-radiation protection circuits also may be called "horizontal disable" or "hold down.") Read and apply the high voltage limits and, if the chassis is so equipped, the X-radiation protection circuit specifications given on instrument labels and in the Product Safety & X-Radiation Warning note on the service data chassis schematic. High voltage is maintained within specified limits by close tolerance safety-related components/adjustments in the high-voltage circuit. If high voltage exceeds specified limits, check each component specified on the chassis schematic and take corrective action.

2. Read and comply with all caution and safety-related notes on or inside the receiver cabinet, on the receiver chassis, or on the picture tube.

3. Design Alteration Warning - Do not alter or add to the mechanical or electrical design of this TV receiver. Design alterations and additions, including, but not limited to circuit modifications and the addition of items such as auxiliary audio and/or video output connections, might alter the safety characteristics of this receiver and create a hazard to the user. Any design alterations or additions will void the manufacturer's warranty and may make you, the servicer, responsible for personal injury or property damage resulting therefrom.

4. Picture Tube Implosion Protection Warning -

The picture tube in this receiver employs integral implosion protection. For continued implosion protection, replace the picture tube only with one of the same type number. Do not remove, install, or otherwise handle the picture tube in any manner without first putting on shatterproof goggles equipped with side shields. People not so equipped must be kept safely away while picture tubes are handled. Keep the picture tube away from your body. Do not handle

the picture tube by its neck. Some "in-line" picture tubes are equipped with a permanently attached deflection yoke; because of potential hazard, do not try to remove such "permanently attached" yokes from the picture tube.

5. Hot Chassis Warning -

a. Some TV receiver chassis are electrically connected directly to one conductor of the AC power cord and may be safety-serviced without an isolation transformer only if the AC power plug is inserted so that the chassis is connected to the ground side of the AC power source. To confirm that the AC power plug is inserted correctly, with an AC voltmeter, measure between the chassis and a known earth ground. If a voltage reading in excess of 1.0V is obtained, *remove and reinsert the AC power plug in the opposite polarity and again measure the voltage potential between the chassis and a known earth ground.

b. Some TV receiver chassis have a circuit which obtain voltage about 70% of AC voltage between chassis and earth ground regardless of the AC plug polarity. This chassis can be safety-serviced only with an isolation transformer inserted in the power line between the receiver and the AC power source, for both personnel and test equipment protection.

c. Some TV receiver chassis have a secondary ground system in addition to the main chassis ground. This secondary ground system is not isolated from the AC power line. The two ground systems are electrically separated by insulation material that must not be defeated or altered.

Note: * In case unit has no polarity AC plug only.

6. Observe original lead dress. Take extra care to assure correct lead dress in the following areas: a. near sharp edges, b. near thermally hot parts-be sure that leads and components do not touch thermally hot parts, c. the AC supply, d. high voltage, and e. antenna wiring. Always inspect in all areas for pinched, out of place, or frayed wiring. Check AC power cord for damage.

7. Components, parts, and/or wiring that appear to have overheated or are otherwise damaged should be replaced with components, parts, or wiring that meet original specifications. Additionally, determine the cause of overheating and/or damage and, if necessary, take corrective action to remove any potential safety hazard.

8. Product Safety Notice - Some electrical and mechanical parts have special safety-related characteristics which are often not evident from visual

inspection, nor can the protection they give necessarily be obtained by replacing them with components rated for higher voltage, wattage, etc.. Parts that have special safety characteristics are identified by a (Δ) on schematics and in parts lists. Use of a substitute replacement that does not have the same safety characteristics as the recommended replacement part might create shock, fire, and/or other hazards. The Product's Safety is under review continu-

ously and new instructions are issued whenever appropriate. Prior to shipment from the factory, our products are strictly inspected to confirm with the recognized product safety and electrical codes of the countries in which they are to be sold. However, in order to maintain such compliance, it is equally important to implement the following precautions when a set is being serviced.

Precautions during Servicing

A. Parts identified by the (Δ) symbol are critical for safety.

Replace only with part number specified.

B. In addition to safety, other parts and assemblies are specified for conformance with regulations applying to spurious radiation. These must also be replaced only with specified replacements.

Examples: RF converters, RF cables, noise blocking capacitors, and noise blocking filters, etc.

C. Use specified internal wiring. Note especially:

- 1) Wires covered with PVC tubing
- 2) Double insulated wires
- 3) High voltage leads

D. Use specified insulating materials for hazardous live parts. Note especially:

- 1) Insulation Tape
- 2) PVC tubing
- 3) Spacers
- 4) Insulators for transistors.

E. When replacing AC primary side components (transformers, power cord, etc.), wrap ends of wires securely about the terminals before soldering.

F. Observe that the wires do not contact heat producing parts (heatsinks, oxide metal film resistors, fusible resistors, etc.)

G. Check that replaced wires do not contact sharp edged or pointed parts.

H. When a power cord has been replaced, check that 10-15 kg of force in any direction will not loosen it.

I. Also check areas surrounding repaired locations.

J. Use care that foreign objects (screws, solder droplets, etc.) do not remain inside the set.

K. Crimp type wire connector

When replacing the power transformer in sets where the connections between the power cord and power transformer primary lead wires are performed using crimp type connectors, in order to prevent shock hazards, perform carefully and precisely the following steps.

Replacement procedure

1) Remove the old connector by cutting the wires at a point close to the connector.

Important: Do not re-use a connector (discard it).

2) Strip about 15 mm of the insulation from the ends of the wires. If the wires are stranded, twist the strands to avoid frayed conductors.

3) Align the lengths of the wires to be connected. Insert the wires fully into the connector.

4) Use the crimping tool to crimp the metal sleeve at the center position. Be sure to crimp fully to the complete closure of the tool.

L. When connecting or disconnecting the VCR connectors, first, disconnect the AC plug from AC supply socket.

Safety Check after Servicing

Examine the area surrounding the repaired location for damage or deterioration. Observe that screws, parts and wires have been returned to original positions. Afterwards, perform the following tests and confirm the specified values in order to verify compliance with safety standards.

1. Clearance Distance

When replacing primary circuit components, confirm specified clearance distance (d) and (d') between soldered terminals, and between terminals and surrounding metallic parts. (See Fig. 1)

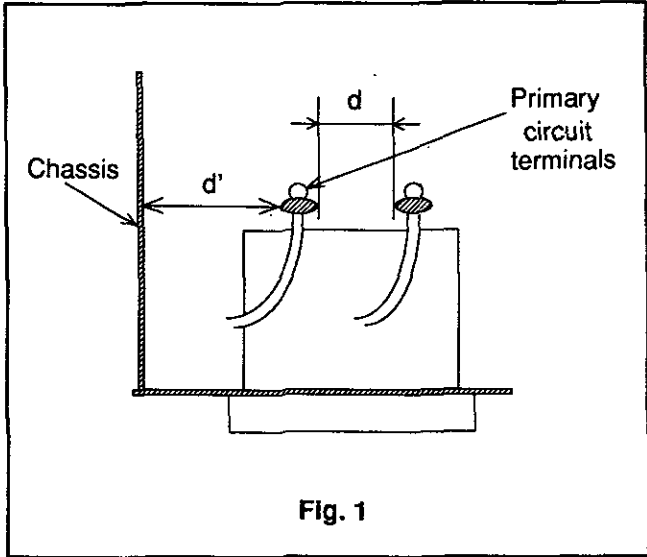

Fig. 1

Table 1 : Ratings for selected area

AC Line Voltage	Region	Clearance Distance (d) (d')
200 to 240 V	Europe	$\geq 4\text{mm}$ (d)
	Australia	$\geq 6\text{mm}$ (d')

Note: This table is unofficial and for reference only. Be sure to confirm the precise values.

2. Leakage Current Test

Confirm specified (or lower) leakage current between B (earth ground, power cord plug prongs) and externally exposed accessible parts (RF terminals, antenna terminals, video and audio input and output terminals, microphone jacks, earphone jacks, etc.).

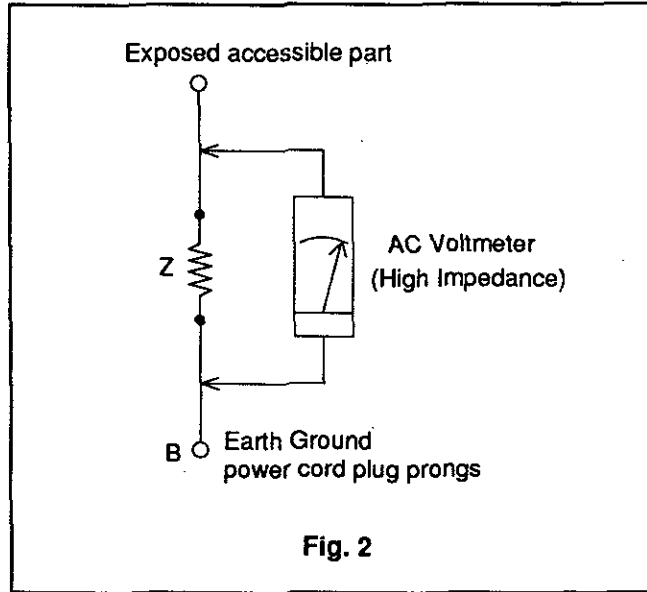

Fig. 2

Measuring Method : (Power ON)

Insert load Z between B (earth ground, power cord plug prongs) and exposed accessible parts. Use an AC voltmeter to measure across both terminals of load Z . See Fig. 2 and following table.

Table 2 : Leakage current ratings for selected areas

AC Line Voltage	Region	Load Z	Leakage Current (i)	Earth Ground (B) to:
200 to 240 V	Europe Australia	2k Ω RES. in connected	$i \leq 0.7\text{mA rms}$ $i \leq 2\text{mA dc}$	Antenna terminals
		50k Ω RES. in connected	$i \leq 0.7\text{mA rms}$ $i \leq 2\text{mA dc}$	Other terminals

Note: This table is unofficial and for reference only. Be sure to confirm the precise values.

DISASSEMBLY INSTRUCTIONS

General Note: "P.C.B." is abbreviation of "Printed Circuit Board".

1. DISASSEMBLY FLOW CHART

This flow chart indicates the disassembly steps of the cabinet parts and P.C.B. in order to gain access to item(s) to be serviced. When reassembling, perform the step(s) in the reverse order. Bend, route and dress the cables as they were originally.

Caution ! : When removing the CRT, make sure to discharge Anode Lead of the CRT. Use the CRT Ground Wire to discharge the CRT before removing the Anode Cap.

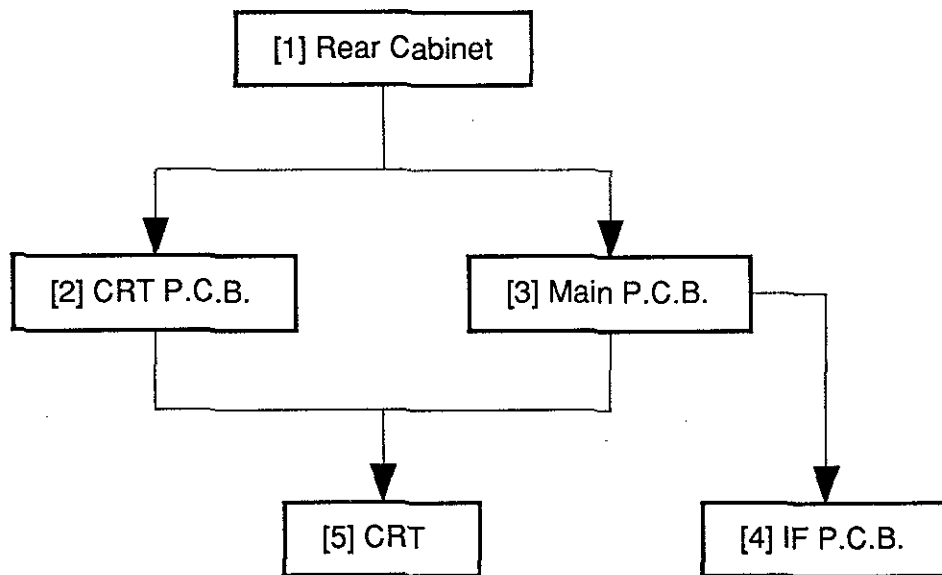

2. DISASSEMBLY METHOD

STEP / LOC. NO.	PART	REMOVAL		
		FIG. NO.	REMOVE / *UNLOCK / RELEASE / UNPLUG / UNCLAMP / DESOLDER	NOTE
[1]	Rear Cabinet	CAB1 CAB2	L2 (4pcs)	1
[2]	CRT P.C.B.	CAB4 CAB5	CN601, CN602, CN603, CN604 FOCUS WIRE, SCREEN WIRE	2
[3]	Main P.C.B.	CAB3 CAB5	CN201, CN202, CN203, CN204, CN501 ANODE CAP, FOCUS WIRE, SCREEN WIRE	3
[4]	IF P.C.B.	CAB3	CN101, CN102	4
[5]	CRT	CAB4	B2 (4pcs)	5

Reference <Notes> in Table

1. (1) Remove 4 screws (L2) and slide the Rear Cabinet backward.
2. (1) If not already removed, first remove the Rear Cabinet.
(2) Remove all relative wires, then pull the CRT P.C.B. backward.
3. (1) If not already removed, first remove the Rear Cabinet.
(2) Remove all relative wires on the Main P.C.B. and remove the Anode Cap, then slide the main P.C.B. backward.
4. (1) If not already removed, first remove the Rear Cabinet.
(2) Desolder CN101 and CN102, then remove the IF P.C.B. from the Main P.C.B..

Caution !

Discharge Anode Lead of the CRT with the CRT Ground Wire before removing the Anode Cap.

5. (1) If not already removed, first remove the Rear Cabinet and Main P.C.B..
(2) Remove 4 screws (B2), then the CRT can be removed.

[1] Rear Cabinet

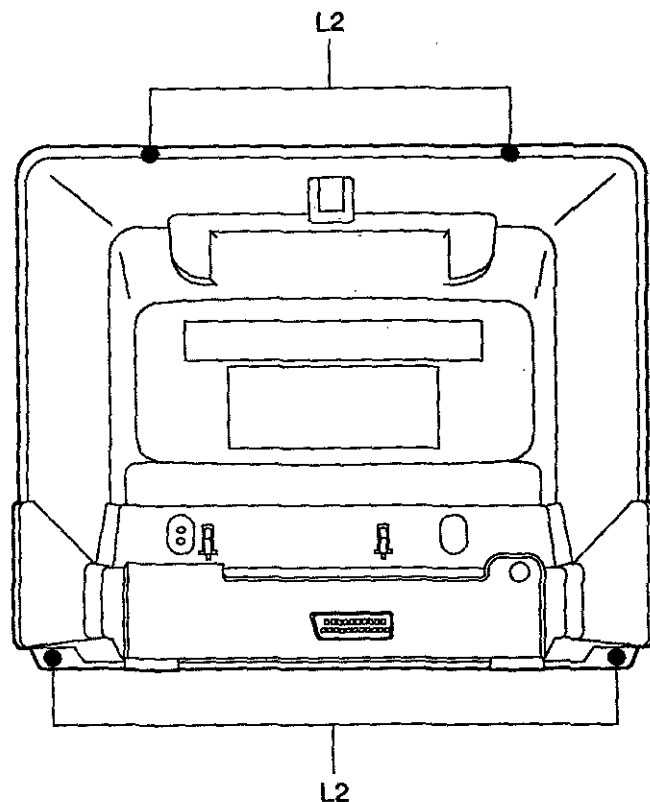

Fig. CAB 1

[1] Rear Cabinet

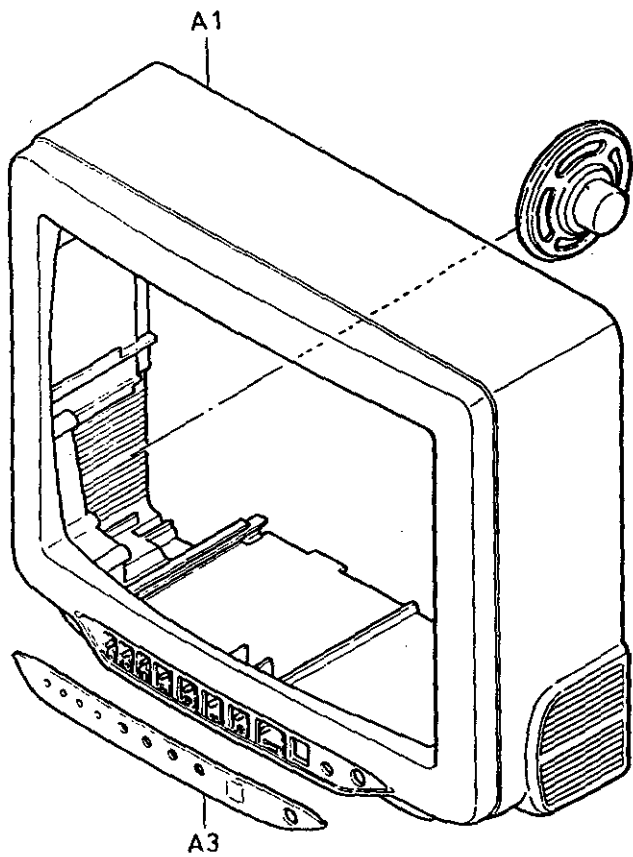
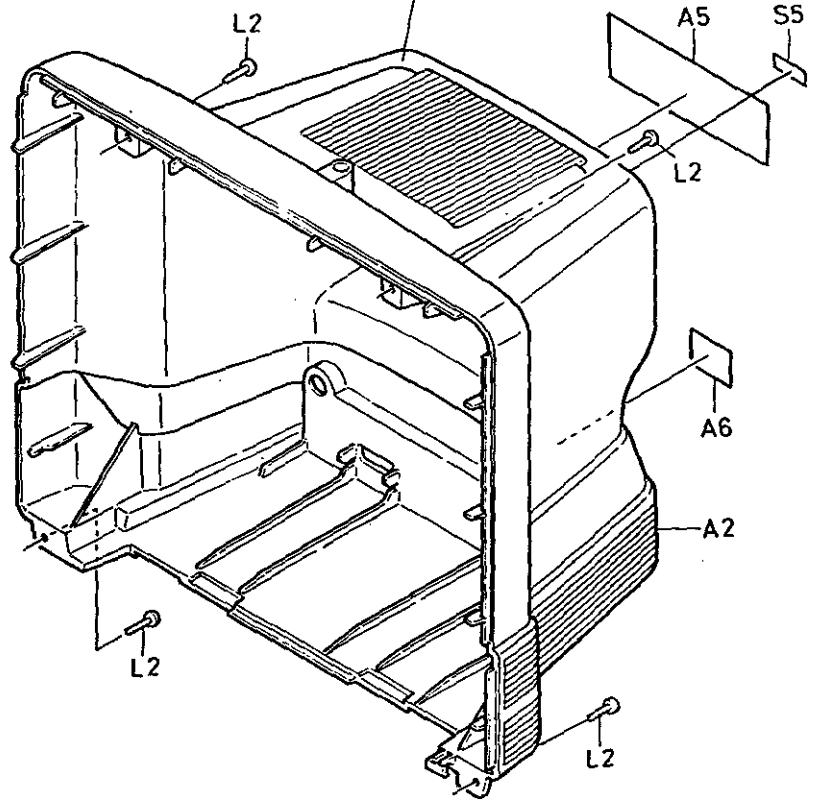

Fig. CAB 2

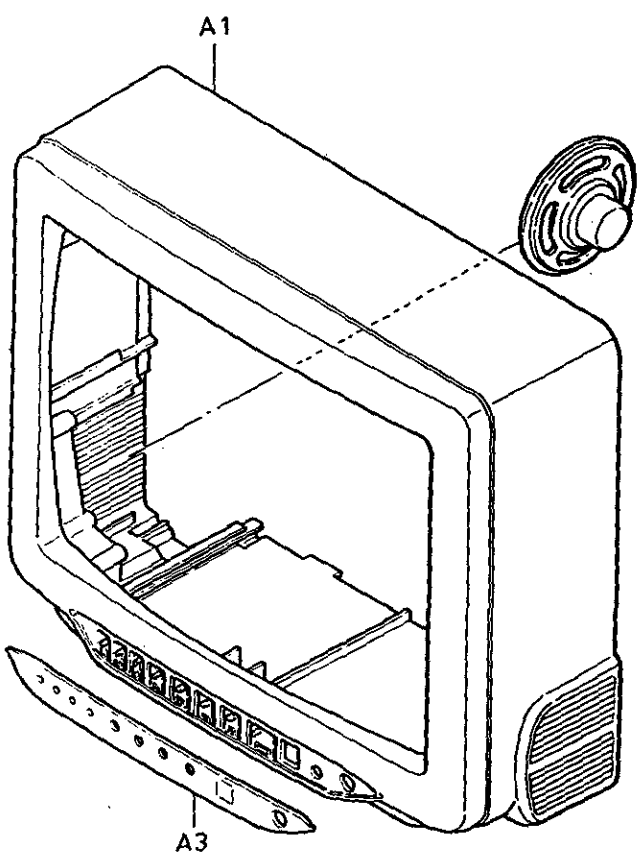
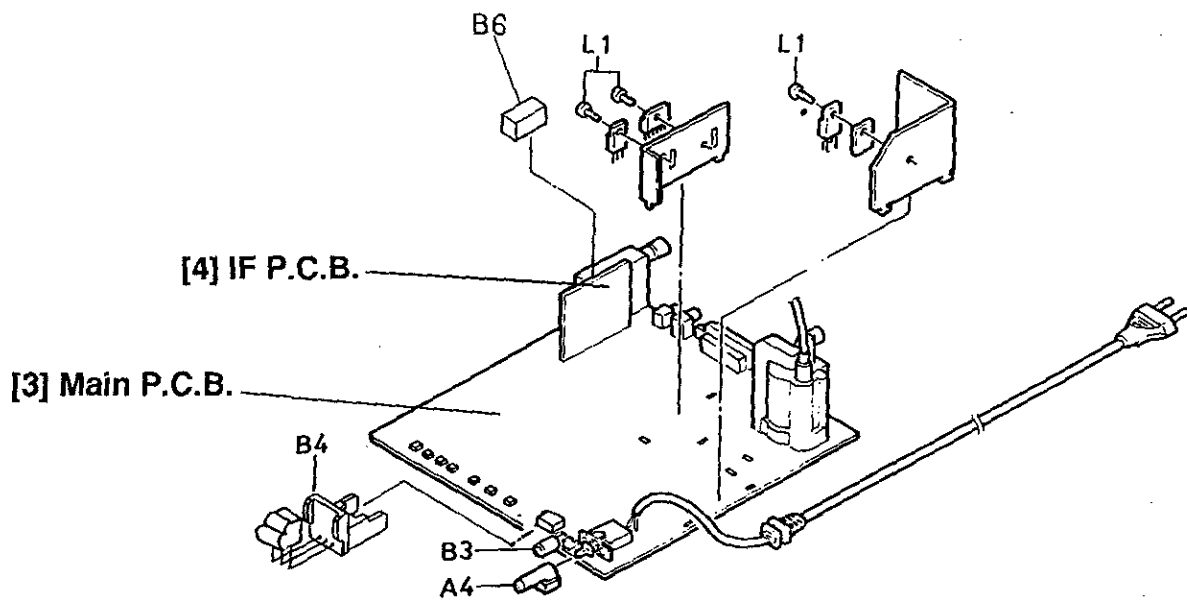

Fig. CAB 3

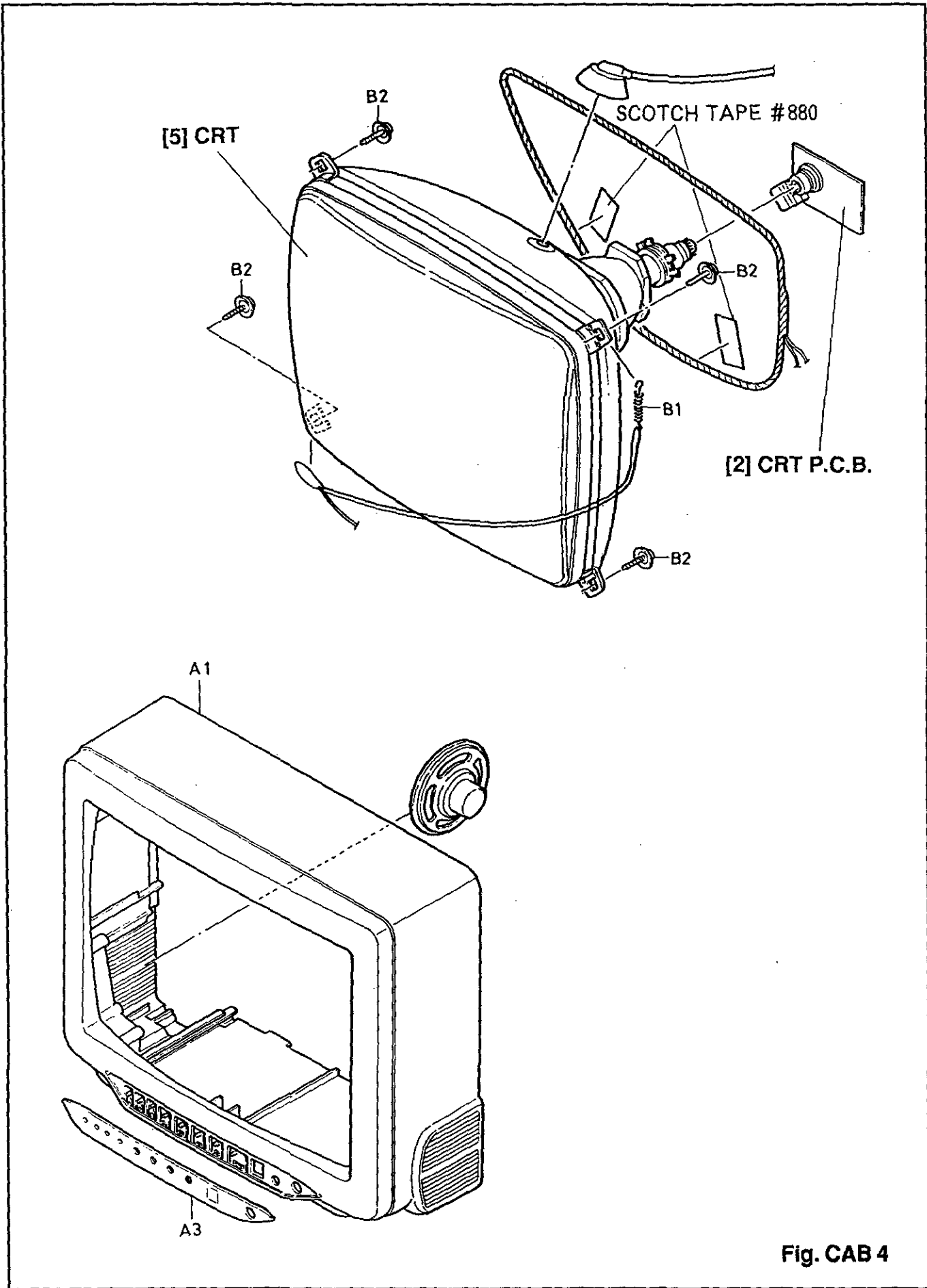
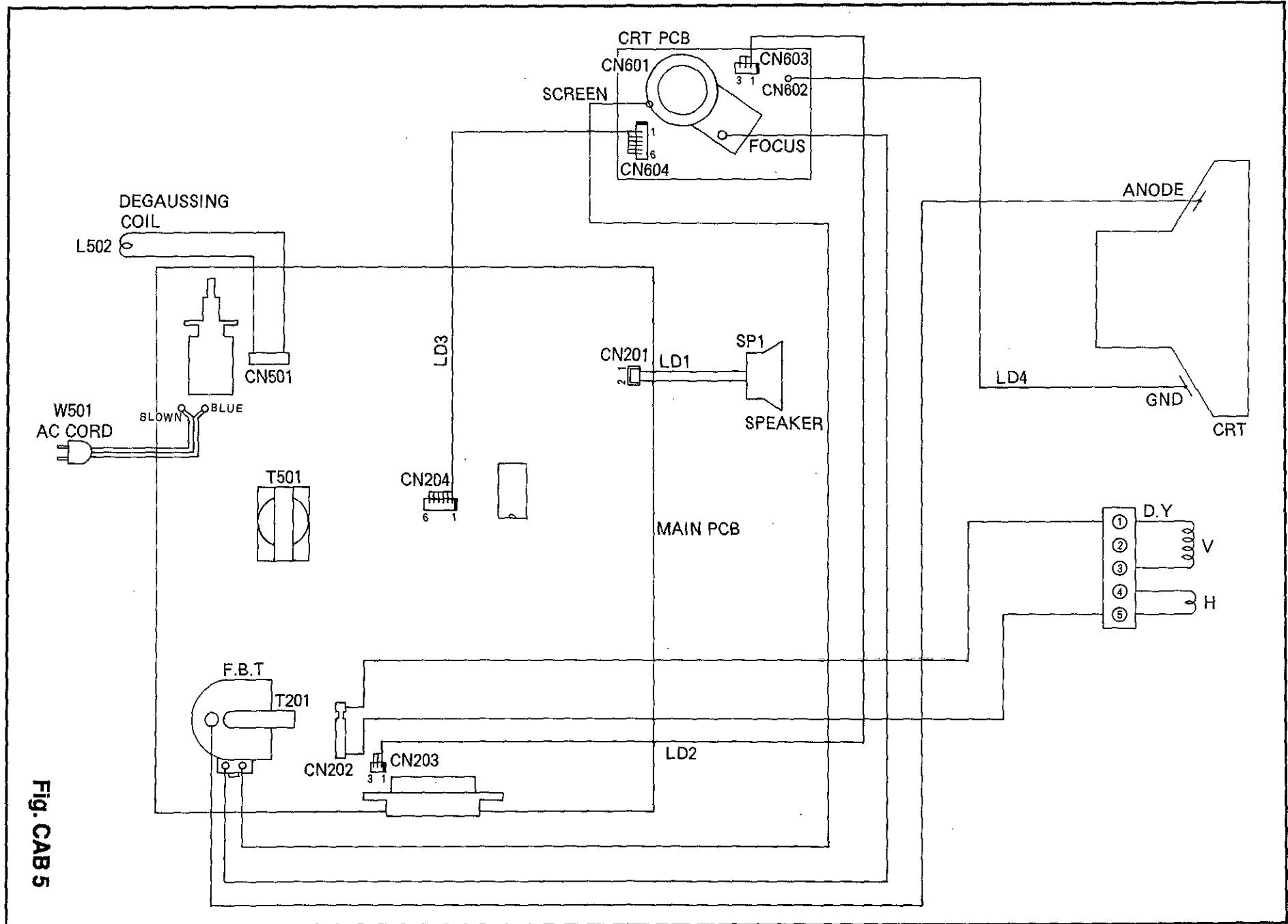

Fig. CAB 4



4-6

Fig. CAB 5

L7456DC

ELECTRICAL ADJUSTMENT INSTRUCTIONS

NOTE:

Electrical adjustments are required after replacing circuit components. It is important to perform these adjustments only after all repairs and replacements have been completed. Also, do not attempt these adjustments unless the proper equipment is available.

TEST EQUIPMENT REQUIRED:

1. IF Sweeper
2. DC Volt Meter.
3. Oscilloscope: Dual Trace with 10:1 probe
4. PAL Pattern Generator
5. Monoscope
6. Color Analyzer

HOW TO SET UP THE ADJUSTMENT MODE:

Preset Mode: Press picture select button on the remote control unit, then press the number "1" button.

Brightness ----- Center

Color ----- Center

Contrast ----- Approx 70%

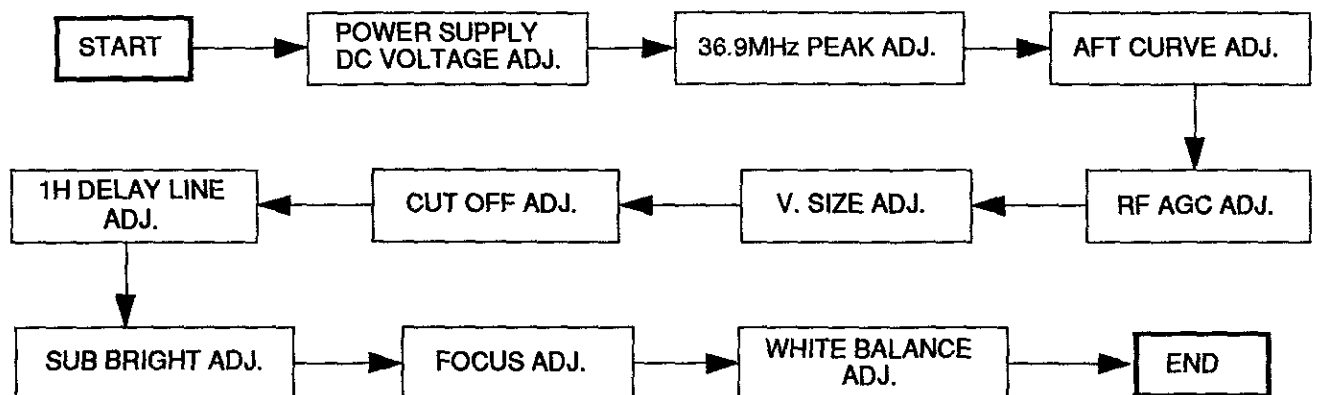

1. POWER SUPPLY DC VOLTAGE ADJUSTMENT

Purpose: To get correct voltage.

Symptom of Misadjustment: If voltage is incorrect, picture is dark.

Test Point	Adjustment Point	Input
D245	VR205	---
Equipment		Spec.
DC Volt Meter		DC +115±0.5V
Connections of M. EQ.		

Reference Notes: D245, VR205 --- MAIN P.C.B.

1. To inactivate F.B.T., ground the base of Q220.
2. Connect both terminal of C343 by 1KΩ (60W~80W).
3. Connect the equipment as shown in the above table.
4. Adjust VR205 for reading +115±0.5V on the DC Volt Meter.

2. 36.9MHz PEAK ADJUSTMENT (for TUNER)

Purpose: To adjust PIF (Picture Intermediate Frequency).

Symptom of Misadjustment: Beat may appear on the picture and buzz may sound.

Test Point	Adjustment Point	Input
IC101 6pin, 16pin	L106	---
Equipment		Spec.
IF Sweeper, Oscilloscope		See below
Figure		

Reference Notes: IC101, L106 --- IF P.C.B.

1. Connect Output of sweeper to 6pin of IC101.
Frequency set of sweeper are below:
(1) 29.4MHz (2) 31.4MHz (3) 32.47MHz (4) 34.7MHz (5) 36.9MHz (6) 38.4MHz
2. Connect the oscilloscope to 16pin of IC101.
3. Load DC Voltage to 4pin of IC101 as the wave of oscilloscope not to clip.
4. Adjust L106 as the marker for 36.9MHz to be peak.

3. AFT CURVE ADJUSTMENT (for TUNER)

Purpose: To operate AFT correctly.

Symptom of Misadjustment: AFT does not work correctly and/or synchronism will be faulty.

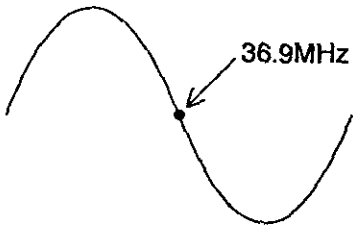
Test Point	Adjustment Point	Input
IC101 6pin, 11pin	L107	---
Equipment		Spec.
IF Sweeper, Oscilloscope		See below
Figure		
		

Reference Notes: SW206 --- MAIN P.C.B. IC101, L107 --- IF P.C.B.

1. Connect output of sweeper to 6pin of IC101.
Frequency set is the same as for 36.9MHz Peak Adjustment.
2. Connect the oscilloscope to 11pin of IC101.
3. Push SW206 to disengage AFT action.
4. Adjust L107 as the marker for 36.9MHz to the center of AFT curve.

4. RF AGC ADJUSTMENT (for TUNER)

Purpose: Set AGC (Auto Gain Control) Level.

Symptom of Misadjustment: AGC does not synchronize correctly when RF Input Level is weak and distortion may cause on the picture when it is strong.

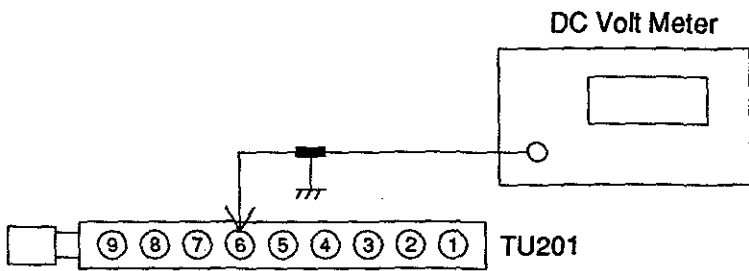
Test Point	Adjustment Point	Input
TU201 6pin	VR101	PAL Color Bar
Equipment		Spec.
PAL Pattern Generator, DC Volt Meter		DC $+4.0 \pm 0.1V$
Connections of M. EQ.		
		

Reference Notes: TU201 --- MAIN P.C.B. VR101 --- IF P.C.B.

1. Receive the PAL Color Bar signal for 0ch (46.25MHz). (RF input level 80dB μ V at the best synchronized point)
2. Connect the equipment as shown in the above table.
3. Adjust VR101 for reading $+4.0 \pm 0.1V$ on the DC Volt Meter.

5. V. SIZE ADJUSTMENT

Purpose: To get correct vertical size of screen image.

Symptom of Misadjustment: Vertical size of screen image may not be properly displayed.

Test Point	Adjustment Point	Input
Screen	VR204	Monoscopic Pattern
Equipment		Spec.
Monoscope		90±5%

Figure

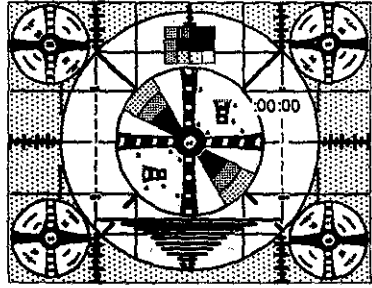

Reference Note: VR204 --- MAIN P.C.B.

1. Operate the unit more than 20 minutes.
2. Input the Monoscopic Pattern.
3. Adjust VR204 so that the vertical size will be 90±5% of Monoscopic Pattern and the circle is round.

6. CUT OFF ADJUSTMENT

Purpose: To adjust the beam current of R, G, B and screen voltage.

Symptom of Misadjustment: White color may be reddish, greenish or bluish.

When the screen voltage is too high, the scanning line is appeared on the screen.

Test Point	Adjustment Point	Input
Screen	VR604, VR605, VR606 Screen-VR (F.B.T.)	Black Raster
Equipment		Spec.
Pattern Generator		See below

Figure

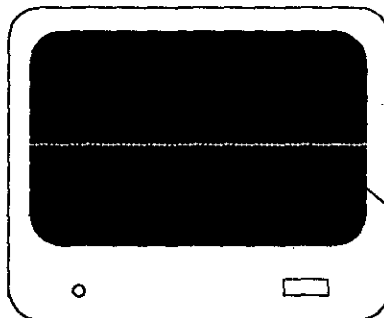

Using this line

Reference Notes: VR601, VR602, VR603, VR604, VR605, VR606 --- CRT P.C.B.

SW209 --- MAIN P.C.B.

Screen-VR --- MAIN P.C.B. (F.B.T.)

1. Operate the unit more than 20 minutes.
2. Degauss the CRT using Degaussing Coil.
3. Input the Black Raster.
4. Turn the Screen-VR (F.B.T.) fully counterclockwise.
5. Set VR602 (B. Drive), VR603 (R. Drive), VR604 (B. Cut Off), VR605 (G. Cut Off), VR606 (R. Cut Off) and VR601 (Sub Bright) to center.
6. Set the SW209 (Service SW) to ON.
7. Slowly turn the Screen-VR (F.B.T.) to the point where horizontal line just visible.
8. Adjust VR604 (Blue), VR605 (Green) and VR606 (Red) so that horizontal line becomes pure white.
9. Turn off the SW209 (Service SW).

Note: Confirm that White Balance Adj. is correct after this adjustment, and attempt White Balance Adj. if needed.

7. 1 H DELAY LINE ADJUSTMENT

Purpose: To get correct 1H delay line when the PAL signal is entered.

Symptom of Misadjustment: The Anti-PAL signal part is colored when the Philips Pattern is entered.

Each scanning line is colored on the color bar.

Test Point	Adjustment Point	Input
TP5 TP1 (GND)	L210, VR203	Philips Pattern
Equipment		Spec.
Pattern Generator Oscilloscope		See below

Connections of M. EQ.

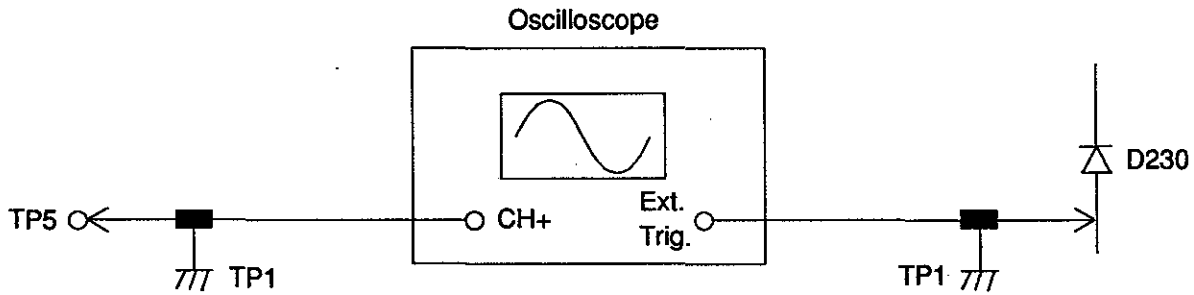

Figure

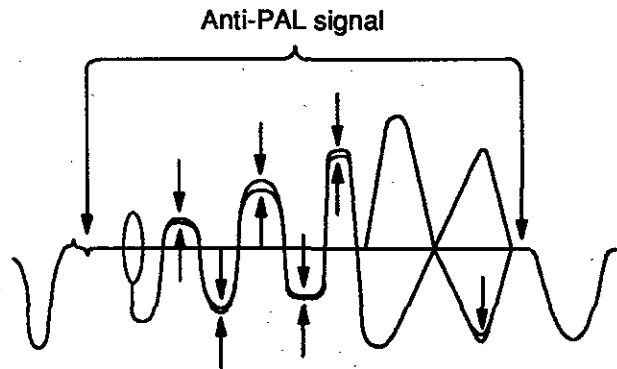
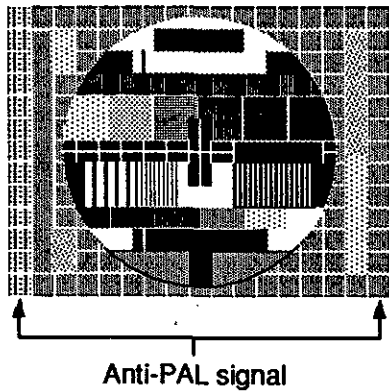

Reference Notes: D230, TP1, TP5, L210, VR203 --- MAIN P.C.B.

1. Input the Philips Pattern.
2. Connect the equipment as shown in the above table.
3. Adjust VR203 and L210 so that the amplitude at Anti-PAL signal part becomes minimum (no color) and the waveform at the color bar part is not seen in double ("Venetian Blind" does not appear at the color bar signal part).

8. SUB BRIGHT ADJUSTMENT

Purpose: To get proper brightness.

Symptom of Misadjustment: Proper brightness cannot be obtained by adjusting the Bright Control.

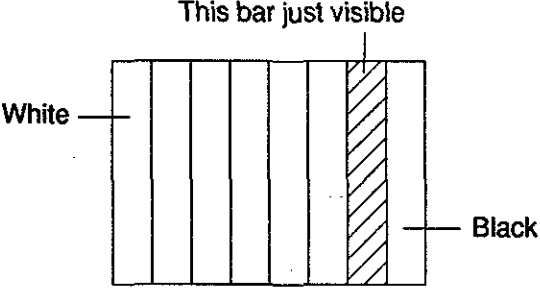
Test Point	Adjustment Point	Input
Screen	VR601	Gray Scale pattern
Equipment		Spec.
Pattern Generator		See below
Figure		
		

Reference Notes: VR601 --- CRT P.C.B.

1. Operate the unit more than 20 minutes.
2. Input the 8-step Gray Scale pattern.
3. Adjust VR601 so that the bar is just visible. (See above figure)

9. FOCUS ADJUSTMENT

Purpose: To get correct focus.

Symptom of Misadjustment: Blurred image is shown on the display.

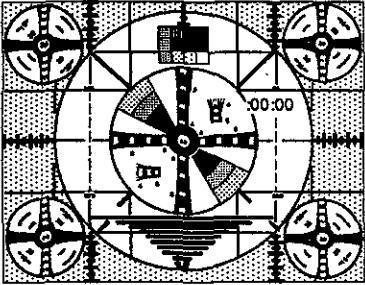
Test Point	Adjustment Point	Input
Screen	Focus-VR (F.B.T.)	Monoscopic Pattern
Equipment		Spec.
Monoscope		See below
Figure		
		

Reference Note: Focus-VR (F.B.T.) --- MAIN P.C.B.

1. Operate the unit more than 20 minutes.
2. Input the Monoscopic Pattern.
3. Adjust Focus-VR (F.B.T.) to be obtained clear picture.

BLOCK DIAGRAM

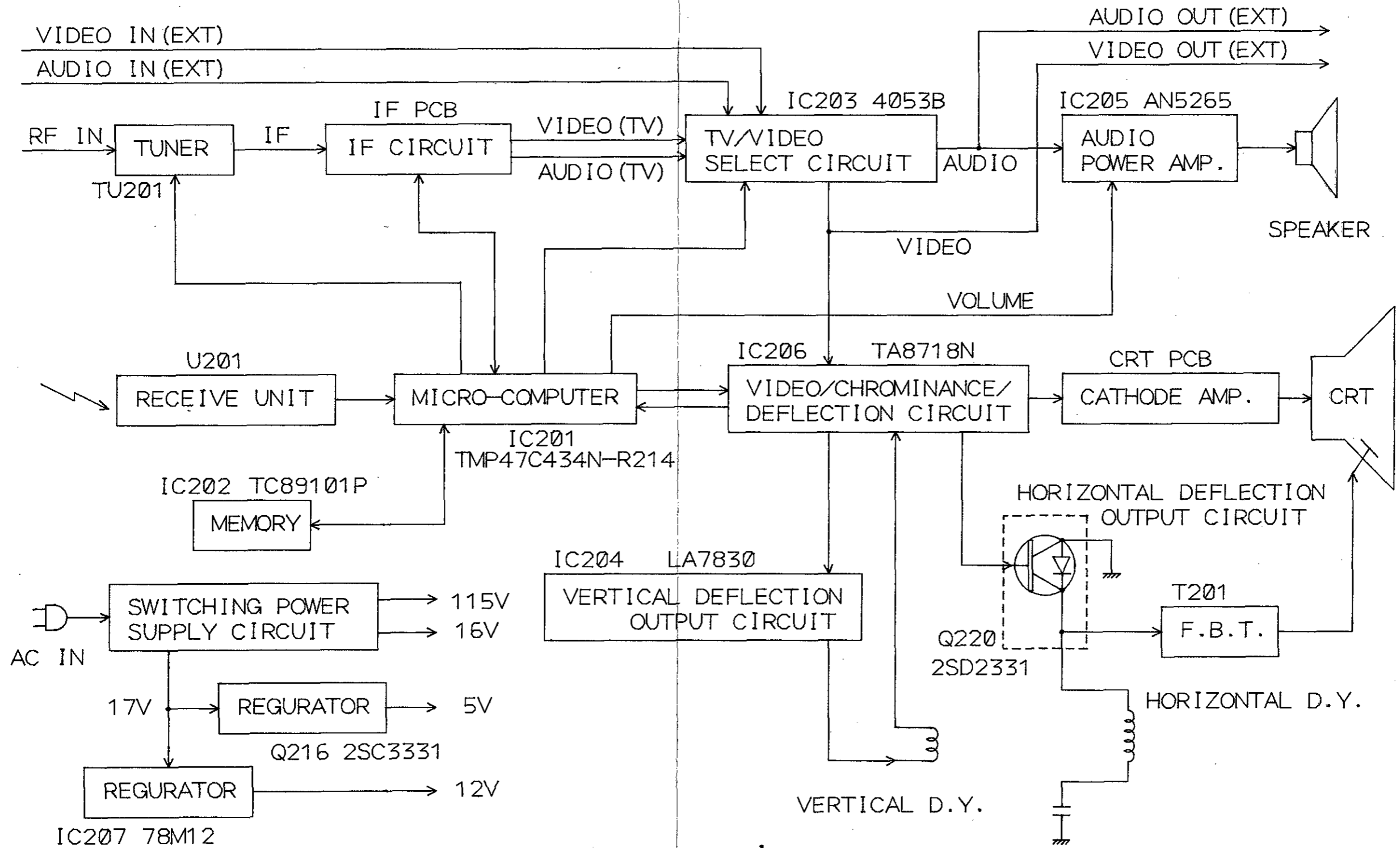

10. WHITE BALANCE ADJUSTMENT

Purpose: To mix red, green and blue beams correctly for pure white.

Symptom of Misadjustment: White becomes bluish or reddish.

Test Point	Adjustment Point	Input
Screen	VR602, VR603	White Raster (APL 100%)
Equipment		Spec.
Pattern Generator Color Analyzer		See below
Connections of M. EQ.		

Reference Notes: VR602, VR603 --- CRT P.C.B.

1. Operate the unit more than 20 minutes.
2. Face the unit to east. Degauss the CRT using Degaussing Coil.
3. Input the White Raster (APL 100%).
4. Set the color analyzer to the CHROMA mode and after zero point calibration, bring the optical receptor to the center on the tube surface (CRT).
5. Adjust VR603 (R. DRIVE) and VR602 (B. DRIVE) so that the respective chroma temperatures become 8000K-10MPCD ($x : 0.300 / y : 0.290$) $\pm 4\%$.

Note: Confirm that Cut Off Adj. is correct after this adjustment, and attempt Cut Off Adj. if needed.

SCHEMATIC DIAGRAMS / P.C.B. AND TEST POINTS

STANDARD NOTES

Warning

Critical components having special safety characteristics are identified with a \triangle by the Ref. No. in the parts list and enclosed within a broken line * (where several critical components are grouped in one area) along with the safety symbol \triangle on the schematics or exploded views.

Use of substitute replacement parts which do not have the same specified safety characteristics may create shock, fire, or other hazards.

Under no circumstances should the original design be modified or altered without written permission from TEAC Corporation. TEAC assumes no liability, express or implied, arising out of any unauthorized modification of design. Servicer assumes all liability.

Notes:

- ① Do not use the part number shown on these drawings for ordering. The correct part number is shown in the parts list, and may be slightly different or amended since these drawings were prepared.
- ② All resistance values are indicated in ohms ($K=10^3$, $M=10^6$).
- ③ Resistor wattages are 1/5W or 1/6W unless otherwise specified.
- ④ All capacitance values are indicated in μF ($P=10^{-6}\mu F$).

Note of Capacitors:

(M) --- Mylar Cap. (SC) --- Semiconductor Cap. (TF) --- Stacked Metallized Film Cap.

Temperature Characteristics of Capacitors are noted with the following:

(YB) --- $\pm 10\%$ (SR) --- $\pm 15\%$ (NP0) --- $0 \pm 60 \text{ppm}/^\circ\text{C}$ (SL) --- $+350 \sim -1000 \text{ppm}/^\circ\text{C}$

Tolerance of Capacitors are noted with the following:

(K) --- $\pm 10\%$ (Z) --- $+80 \sim -20\%$

Note of Resistor:

(F) --- Fuse Res.

MAIN P.C.B. TOP VIEW

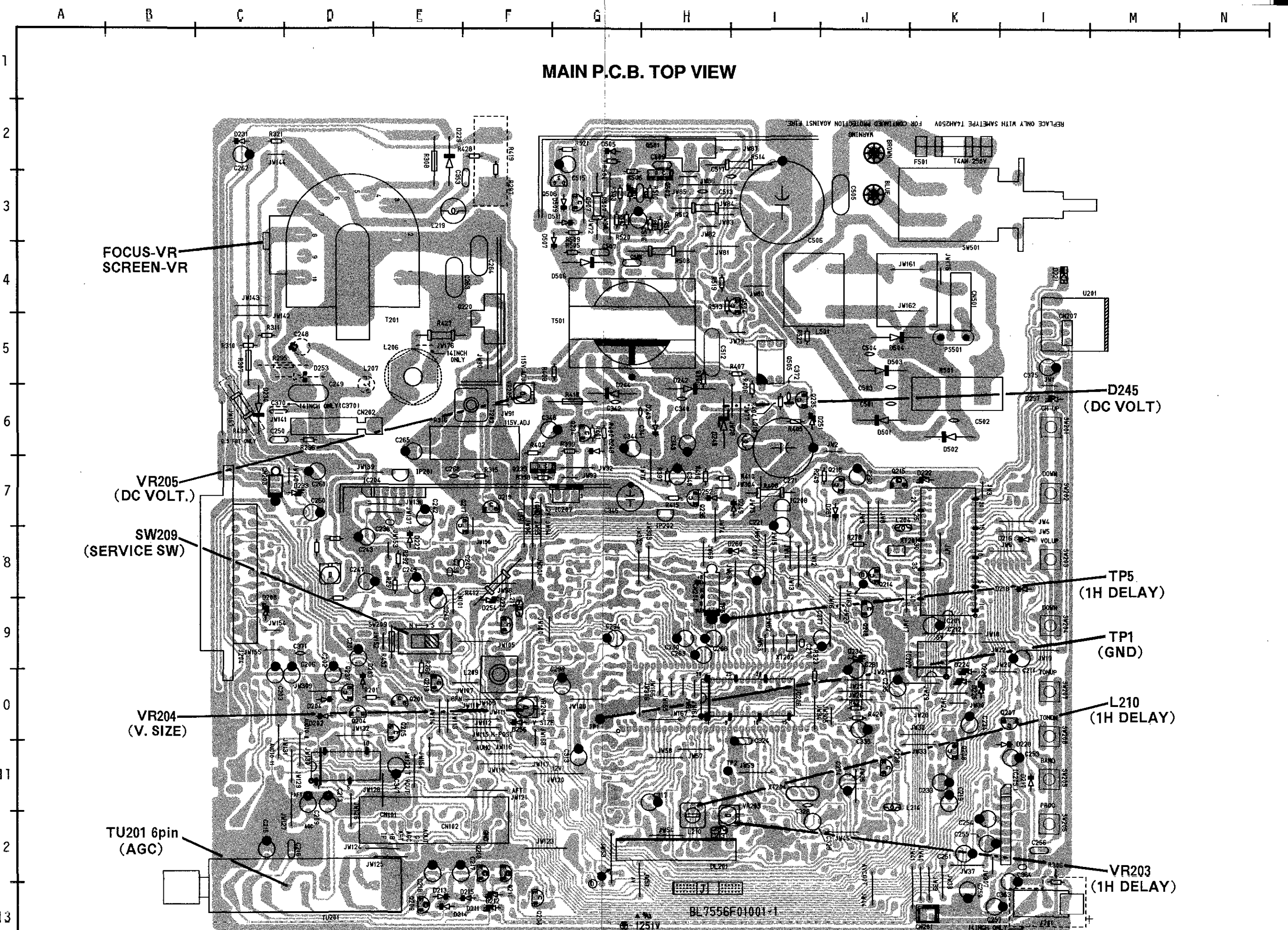

A R C D F F G H I J K L M N

1
2
3
4
5
6
7
8
9
10
11
12
13

MAIN P.C.B. BOTTOM VIEW

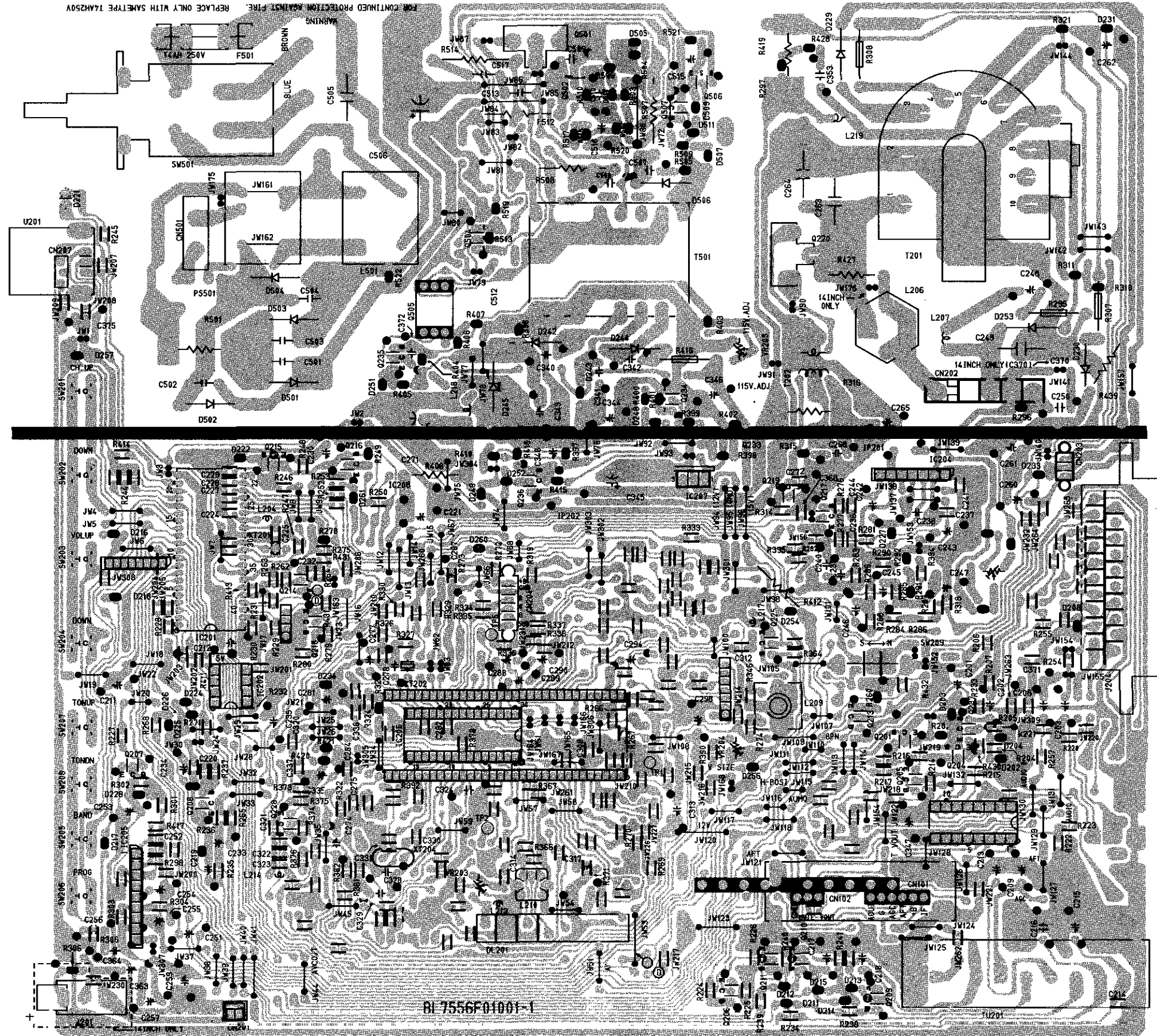

WARNING: FOR CONTINUED PROTECTION AGAINST FIRE, REPLACE ONLY WITH SAME TYPE 14MH250V

BI 7556F01001-1

ELECTICAL PARTS LIST

MMA PCB ASSY

MMA PCB ASSY

REF. NO.	PARTS NO.	DESCRIPTION
	*9A04117000	MMA PCB ASSY (Consists of PCB-MAIN,CRT,IF ASSY)
	*9A04117100	PCB, MMA (Consists of MAIN,CRT,IF PCB)

MAIN PCB ASSY SECTION

C248	9A04118700	C., ELEC 1UF/250V
C248	9A02405800	C., ELEC 1UF/250V
C248	9A01467200	C., ELEC 1UF/250V
C249	9A02405500	C.,METAL POLY 0.47UF/200V
C249	9A01813600	C.,METAL 1ZED 0.47UF/200V
C260	9A04119000	C., ELEC 2.2UF/250V
C260	9A04119100	C., ELEC 2.2UF/250V
C262	9A04119300	C., ELEC 1UF/100V
C263	9A02772300	C., FILM 6800PF/1.6KV
C263	9A02772400	C., FILM 6800PF/1.6KV
C265	9A04119400	C., ELEC 0.47UF/160V
C268	9A04119500	C., CERAMIC 0.0022UF/500V
C271	9A04119600	C., ELEC 47UF/160V (105°C)
C271	9A04119700	C., ELEC 47UF/160V (105°C)
C340	9A04120900	C., CERAMIC 470PF/500V
C343	9A04121100	C., ELEC 100UF/160V (105°C)
C343	9A02771500	C., ELEC 100UF/160V (105°C)
C376	9A04121400	C., CERAMIC 0.001UF/500V
C501-504 Δ	9A04121800	C., CERAMIC 2200PF/AC400V
C501-504 Δ	9A04121900	C., CERAMIC 2200PF/AC400V
C505	9A01808700	C.,LINE ACROSS 0.1UF/250V
C505	9A02411200	C.,LINE ACROSS 0.1UF/250V
C505	9A02771800	C.,LINE ACROSS 0.1UF/250V
C506	9A04122000	C., ELEC 150UF/400V
C508	9A04122200	C., CERAMIC 680PF/2KV
C508	9A04122300	C., CERAMIC 680PF/2KV
C512	Δ 9A03817000	C., CERAMIC 0.0022UF/T4KV
C512	Δ 9A01809000	C., CERAMIC 0.0022UF/T4KV
C513	9A03809600	C., CERAMIC 0.0022UF/1KV
C513	9A03809700	C., CERAMIC 0.0022UF/1KV
C517	9A03809600	C., CERAMIC 0.0022UF/1KV
C517	9A03809700	C., CERAMIC 0.0022UF/1KV
CN201	9A00490100	CONNECTOR BASE, 2P
CN202	9A01455800	CONNECTOR BASE, 5P
CN202	9A01856300	CONNECTOR BASE, 5P
CN202	9A01815500	CONNECTOR BASE, 5P
CN203	9A04122600	CABLE HOLDER, 3P
CN203	9A04122700	CABLE HOLDER, 3P
CN204	9A04122800	CABLE HOLDER, 6P
CN204	9A04122900	CABLE HOLDER, 6P
CN501	9A03839200	CONNECTOR BASE, 2P
CN501	9A01809200	CONNECTOR BASE, 2P
D-D	9A04135200	WIRE, LEAD
D202, 204	9A01849900	DIODE, ISS133T
D202, 204	9A04123000	DIODE, ISS176
D208	9A04123100	ZENER DIODE, MTZ12(C)
D211, 212	9A03831400	ZENER DIODE, MTZ7.5BT
D213-218	9A01849900	DIODE, ISS133T
D213-218	9A04123000	DIODE, ISS176

REF. NO.	PARTS NO.	DESCRIPTION
D221	9A02400000	LED, SLR-55VC 3F
D221	9A04123200	LED, KLRI33L
D222	9A04123300	ZENER DIODE, MTZ5.1(C)
D224-226	9A00874100	ZENER DIODE, MTZ5.1B-T77
D227	9A03831300	DIODE, ERA15-02KFRB
D228	9A01849900	DIODE, ISS133T
D228	9A04123000	DIODE, ISS176
D229	9A03269200	DIODE, ERB12-02L3
D230	9A04123400	DIODE, ERB44-04L3
D231	9A02773700	DIODE, ISS130T
D233	9A02773600	ZENER DIODE, MTZ20B
D234	9A01849600	ZENER DIODE, MTZ9.1(C)
D242	9A03831700	DIODE, ERD38-06L
D243	9A04123500	DIODE, ERC30-02
D244	9A04123600	DIODE, ERB44-02L3
D245	9A03831900	DIODE, R2MLF-B1
D245	9A03832000	DIODE, EQB01-150
D248, 249	9A01849900	DIODE, ISS133T
D248, 249	9A04123000	DIODE, ISS176
D251	9A02927400	ZENER DIODE, MTZ6.8BT
D252	9A01849900	DIODE, ISS133T
D252	9A04123000	DIODE, ISS176
D254	9A02365300	ZENER DIODE, MTZ8.2B
D256	9A01849900	DIODE, ISS133T
D256	9A04123000	DIODE, ISS176
D260, 261	9A01849900	DIODE, ISS133T
D260, 261	9A04123000	DIODE, ISS176
D501-504	9A04123700	DIODE, ERC04-10L3
D505	9A01849900	DIODE, ISS133T
D505	9A04123000	DIODE, ISS176
D506	9A04123600	DIODE, ERB44-02L3
D507, 509	9A01849900	DIODE, ISS133T
D507, 509	9A04123000	DIODE, ISS176
D510	9A04123800	ZENER DIODE, MTZ15(B)
D511	9A01849900	DIODE, ISS133T
D511	9A04123000	DIODE, ISS176
DL201	9A02772000	GLASS DELAY
DL201	9A01455000	GLASS DELAY
F501	Δ 9A03839400	FUSE, T4AH 250V
FH501, 502	9A03839500	FUSE HOLDER
FH501, 502	9A00521100	FUSE HOLDER
FH501, 502	9A03274100	FUSE HOLDER
HS 1	9A04116700	HEAT SINK, PR
HS 2	9A04116800	HEAT SINK, PS
IC201	9A04123900	IC, TMP47C634N-R214
IC202	9A04124000	IC, TC89101P
IC203	9A04124100	IC, TC4053BP
IC203	9A04124200	IC, BU4053B
IC204	9A01817800	IC, LA7830
IC205	9A01817600	IC, AN5265
IC206	9A02401300	IC, TA8718N
IC207	9A02779800	IC, NJM78M12FA
IC207	9A02401000	IC, 78M12
IC207	9A02400900	IC, 78M12
IC207	9A01850600	IC, LC78M12
IC208	9A00742300	IC, L5631
IP201	9A04135300	IC, PROTECTOR, ICP-N10

MMA PCB ASSY

MMA PCB ASSY

REF. NO.	PARTS NO.	DESCRIPTION	REF. NO.	PARTS NO.	DESCRIPTION
IP202	9A04135400	IC, PROTECTOR, ICP-N15	Q215	9A04125800	TR., 2SA564(R)
J201	9A04135500	JACK, EARPHONE	Q215	9A04125900	TR., 2SA564(S)
J204	9A02409800	CONNECTOR BASE, 21P	Q215	9A04126000	TR., KTA1267(GR)
J204	9A02409900	CONNECTOR BASE, 21P	Q216-218	9A03833500	TR., 2SC3331AANP(T)
L204	9A02389500	INDUCTOR, 39UH K	Q216-218	9A03833600	TR., 2SC3331AANP(U)
L207	9A02402200	POT TYPE COIL, 4.7MH	Q216-218	9A03833400	TR., 2SC1815GRTPE2(GR)
L209	9A02404400	DELAY LINE	Q216-218	9A03833800	TR., 2SC1740S(R)
L210	9A04124300	CASING COIL, PAL ADJ.	Q216-218	9A04125200	TR., 2SC1740S(S)
L213	9A04124400	MICRO INDUCTOR, 10UH K	Q216-218	9A04125300	TR., 2SC1685(R)
L213	9A03269800	MICRO INDUCTOR, 10UH K	Q216-218	9A04125400	TR., 2SC1685(S)
L214	9A04124500	MICRO INDUCTOR, 27UH K	Q216-218	9A04125500	TR., KTC3199
L214	9A02419700	MICRO INDUCTOR, 27UH K	Q219	9A04126100	TR., 2SC2271(D)
L217	9A04124600	MICRO INDUCTOR, 33UH K	Q219	9A04126200	TR., 2SC2271(E)
L217	9A02389000	MICRO INDUCTOR, 33UH K	Q220	9A04126300	TR., 2SD2331
L218,219	9A04124700	POT TYPE COIL, 47UH	Q225,228	9A03833500	TR., 2SC3331AANP(T)
L218,219	9A04124800	POT TYPE COIL, 47UH	Q225,228	9A03833600	TR., 2SC3331AANP(U)
L501	△ 9A04124900	LINE FILTER	Q225,228	9A03833400	TR., 2SC1815GRTPE2(GR)
L501	△ 9A04125000	LINE FILTER	Q225,228	9A03833800	TR., 2SC1740S(R)
L501	△ 9A01809500	LINE FILTER	Q225,228	9A04125200	TR., 2SC1740S(S)
LD 2	9A04135600	WIRE, RIBBON 3P	Q225,228	9A04125300	TR., 2SC1685(R)
LD 3	9A04135700	WIRE, RIBBON 6P	Q225,228	9A04125400	TR., 2SC1685(S)
PS501	△ 9A02410400	POSISTER	Q225,228	9A04125500	TR., KTC3199
Q201	9A03833500	TR., 2SC3331AANP(T)	Q233	9A04126400	TR., 2SB1274(R)
Q201	9A03833600	TR., 2SC3331AANP(U)	Q233	9A04126500	TR., 2SB1274(S)
Q201	9A03833400	TR., 2SC1815GRTPE2(GR)	Q234-237	9A03833500	TR., 2SC3331AANP(T)
Q201	9A03833800	TR., 2SC1740S(R)	Q234-237	9A03833600	TR., 2SC3331AANP(U)
Q201	9A04125200	TR., 2SC1740S(S)	Q234-237	9A03833400	TR., 2SC1815GRTPE2(GR)
Q201	9A04125300	TR., 2SC1685(R)	Q234-237	9A03833800	TR., 2SC1740S(R)
Q201	9A04125400	TR., 2SC1685(S)	Q234-237	9A04125200	TR., 2SC1740S(S)
Q201	9A04125500	TR., KTC3199	Q234-237	9A04125300	TR., 2SC1685(R)
Q204-208	9A03833500	TR., 2SC3331AANP(T)	Q234-237	9A04125400	TR., 2SC1685(S)
Q204-208	9A03833600	TR., 2SC3331AANP(U)	Q234-237	9A04125500	TR., KTC3199
Q204-208	9A03833400	TR., 2SC1815GRTPE2(GR)	Q501	9A04126600	TR., 2SD1710CA
Q204-208	9A03833800	TR., 2SC1740S(R)	Q502	9A04126700	TR., 2SC3807
Q204-208	9A04125200	TR., 2SC1740S(S)	Q504	9A04126800	TR., 2SB698(F)
Q204-208	9A04125300	TR., 2SC1685(R)	Q504	9A04126900	TR., 2SB698(G)
Q204-208	9A04125400	TR., 2SC1685(S)	Q505	△ 9A03945800	PHOTO COUPLER, PC111LYS
Q204-208	9A04125500	TR., KTC3199	Q506	9A04127000	FET, 2SK212(E)
Q209-211	9A03834200	TR., 2SA1318AANP(T)	Q506	9A04127100	FET, 2SK212(F)
Q209-211	9A03834300	TR., 2SA1318AANP(U)	Q507	9A03833500	TR., 2SC3331AANP(T)
Q209-211	9A04125600	TR., 2SA933S(R)	Q507	9A03833600	TR., 2SC3331AANP(U)
Q209-211	9A04125700	TR., 2SA933S(S)	Q507	9A03833400	TR., 2SC1815GRTPE2(GR)
Q209-211	9A04125800	TR., 2SA564(R)	Q507	9A03833800	TR., 2SC1740S(R)
Q209-211	9A04125900	TR., 2SA564(S)	Q507	9A04125200	TR., 2SC1740S(S)
Q209-211	9A04126000	TR., KTA1267(GR)	Q507	9A04125300	TR., 2SC1685(R)
Q213,214	9A03833500	TR., 2SC3331AANP(T)	Q507	9A04125400	TR., 2SC1685(S)
Q213,214	9A03833600	TR., 2SC3331AANP(U)	Q507	9A04125500	TR., KTC3199
Q213,214	9A03833400	TR., 2SC1815GRTPE2(GR)	R295	△ 9A04129700	R., FUSE 1/2W 68
Q213,214	9A03833800	TR., 2SC1740S(R)	R295	△ 9A03835600	R., FUSE 1/2W 68
Q213,214	9A04125200	TR., 2SC1740S(S)	R307,308	△ 9A04130200	R., FUSE 1W 2.2
Q213,214	9A04125300	TR., 2SC1685(R)	R307,308	△ 9A02772200	R., FUSE 1W 2.2 J
Q213,214	9A04125400	TR., 2SC1685(S)	R316	9A04130400	R., CEMENT 5W 3.3K
Q213,214	9A04125500	TR., KTC3199	R316	9A04130500	R., CEMENT 5W 3.3K
Q215	9A03834200	TR., 2SA1318AANP(T)	R316	9A04130600	R., CEMENT 5W 3.3K
Q215	9A03834300	TR., 2SA1318AANP(U)	R408	9A04131900	R., METAL 1W 15K
Q215	9A04125600	TR., 2SA933S(R)	R408	9A01458500	R., METAL 1W 15K J
Q215	9A04125700	TR., 2SA933S(S)	R412	9A04132100	R., METAL 2W 27

MMA PCB ASSY

REF. NO.	PARTS NO.	DESCRIPTION
Q104	9A03834200	TR., 2SA1318AANP(T)
Q104	9A03834300	TR., 2SA1318AANP(U)
Q104	9A04125600	TR., 2SA933S(R)
Q104	9A04125700	TR., 2SA933S(S)
Q104	9A04125800	TR., 2SA564(R)
Q104	9A04125900	TR., 2SA564(S)
Q104	9A04126000	TR., KTA1267(GR)
SAW101	9A04139200	SAW FILTER
VR101	9A04137100	VR, SEMI-FIXED 10KB
VR101	9A04137200	VR, SEMI-FIXED 10KB

VOLTAGE CHARTS

(Unit: Volt)

Pin No.	IC101	IC201	IC202	IC203	IC204	IC205
1	5.7	4.6	5.0	6.0	0	11.0
2	4.7	3.5	2.5	5.9	13.0	4.9
3	5.4	2.6	2.5	6.9	27.4	NC
4	3.9	2.0	5.0	6.9	0.8	*0.7~11.3
5	3.9	*5.0~0.1	0	7.0	0.7	7.2
6	4.3	0	5.0	0	27.0	7.4
7	4.3	5.0	5.0	0	1.7	0
8	0	0	5.0	0		7.5
9	1.4	2.4		11.7		15.5
10	4.8	2.5		11.7		
11	6.0	2.5		11.7		
12	3.8	5.0		4.6		
13	8.4	5.0		5.0		
14	8.4	5.0		5.0		
15	3.8	5.0		6.0		
16	4.4	5.0		11.7		
17	11.7	0				
18	0	NC				
19	3.0	5.0				
20	3.0	3.5				
21		0				
22		NC				
23		0				
24		0				
25		0				
26		4.1				
27		5.0				
28		3.0				
29		3.0				
30		0				
31		—				
32		—				
33		4.9				
34		0				
35		5.0				
36		4.5				
37		0				
38		5.0				
39		0				
40		0				
41		0				
42		5.0				

* Vol. Min~Max

(Unit: Volt)

Pin No.	IC206	IC207	IC208	IC209	IC210
1	12.1	16.3	32.0	2.5	11.8
2	11.3	0	0	2.5	0
3	3.6	11.8		4.9	8.9
4	6.4			4.9	
5	10.4			1.7	
6	0			1.7	
7	3.7			2.5	
8	11.1			2.6	
9	6.1			3.3	
10	3.3			2.7	
11	0.9			2.7	
12	9.0			1.7	
13	6.1			0.2	
14	6.1			0	
15	6.3			2.2	
16	2.9			3.8	
17	0.5			2.3	
18	6.7			1.7	
19	—			4.9	
20	2.0			4.9	
21	8.2			2.5	
22	4.6			2.5	
23	4.6			0	
24	4.5			2.5	
25	4.4				
26	4.5				
27	4.5				
28	3.8				
29	3.1				
30	3.7				

NOTES:

- Input:** PAL Color Bar Signal (with 1KHz Audio Signal)
- Receiving Ch.:** 0 ch (46.25 MHz)
- Preset Mode:** Press Picture Select button on the remote control unit, then press the number "1" button.
 - Brightness--- Center
 - Color--- Center
 - Contrast--- Approx 70%

WAVEFORM PHOTOGRAPHS

WF1 ~ WF20 = Waveforms to be observed at
Waveform check points.
(Shown in Schematic Diagram.)

INPUT: PAL Color Bar Signal (with 1KHz Audio Signal)
RECEIVING CH.: 0 ch (46.25 MHz)
PRESET MODE: Press Picture Select button on the remote control unit,
then press the number "1" button.
(Brightness— Center Color— Center Contrast— Approx 70%)

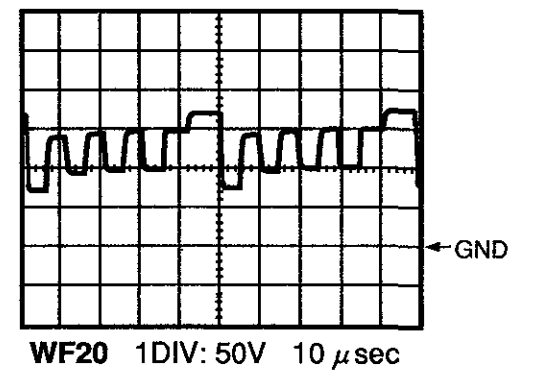
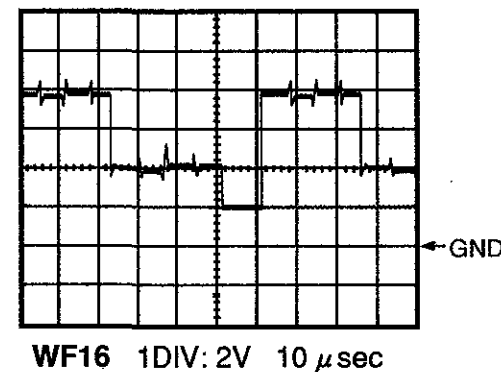
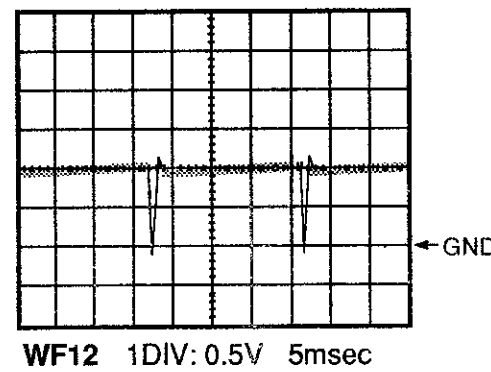
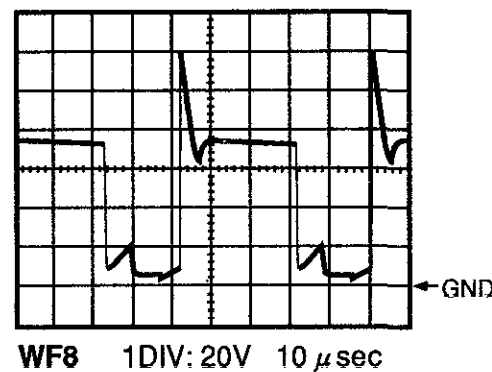
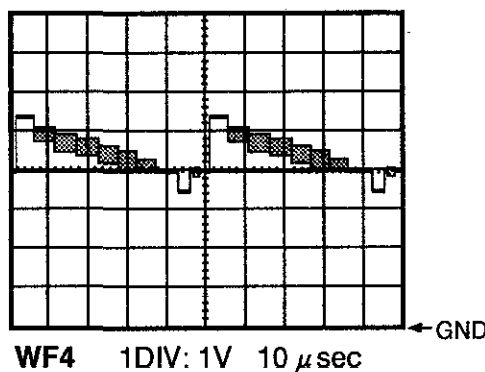
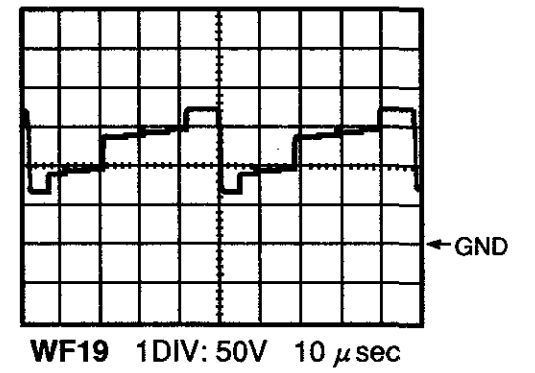
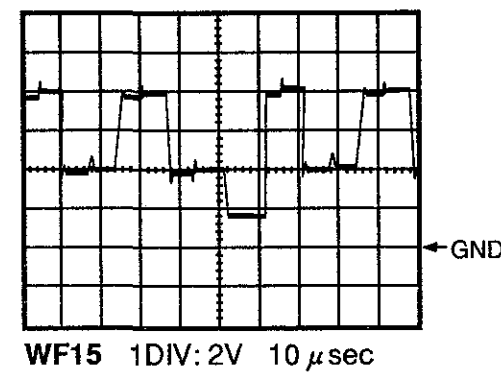
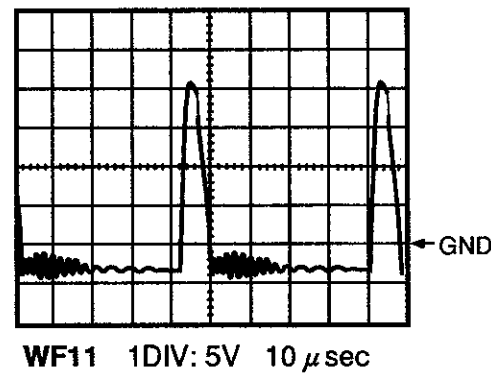
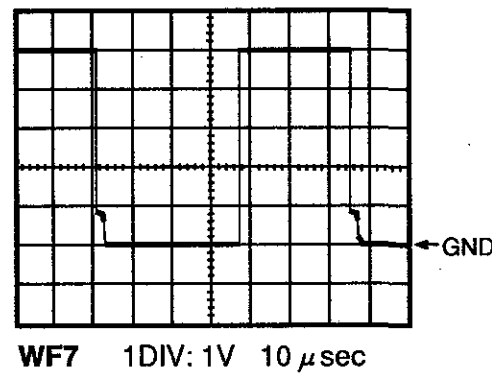
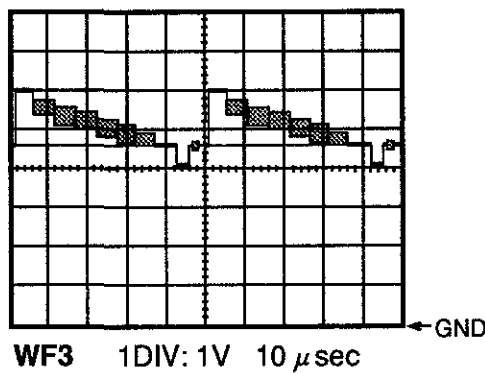
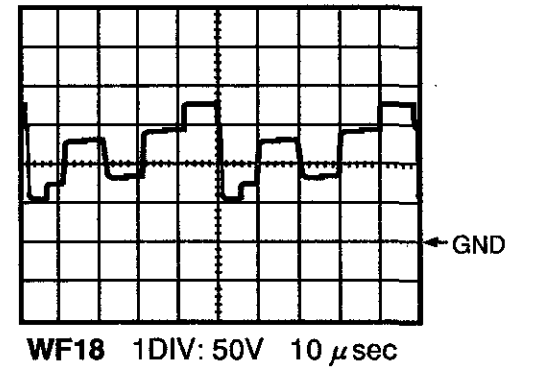
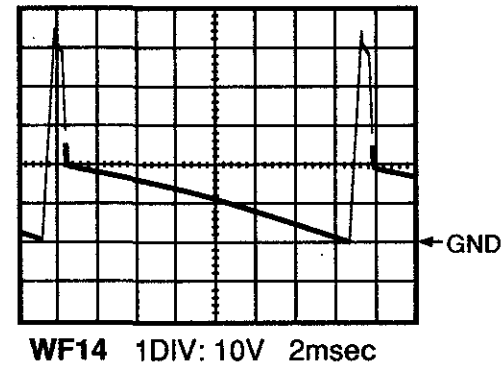
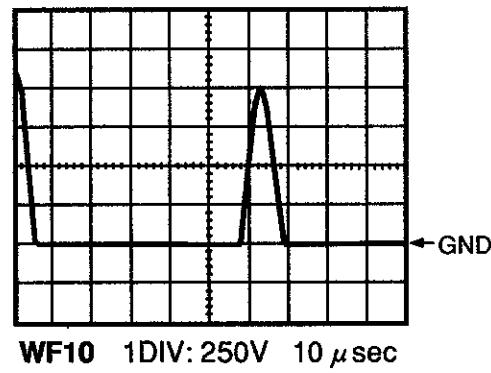
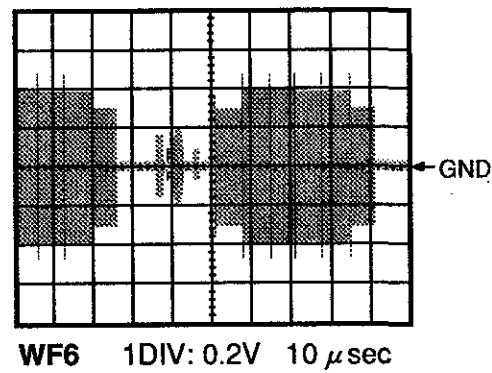
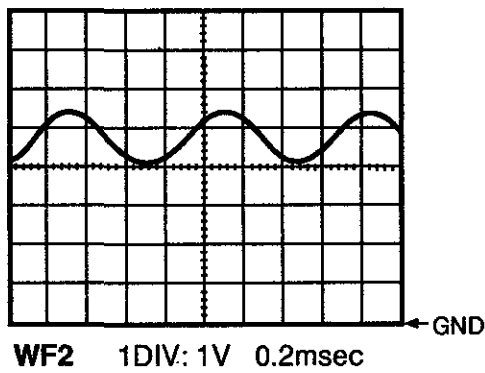
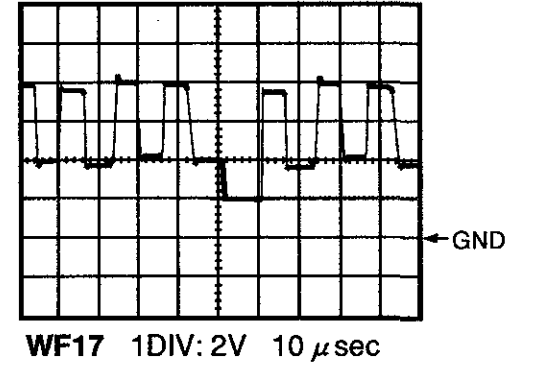
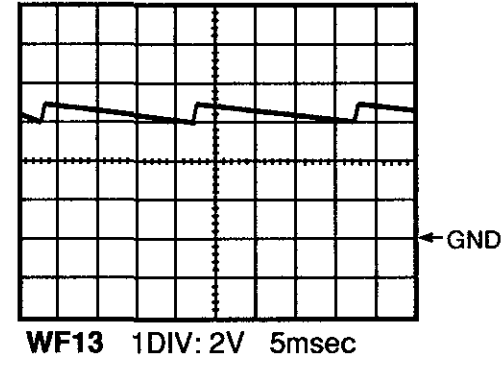
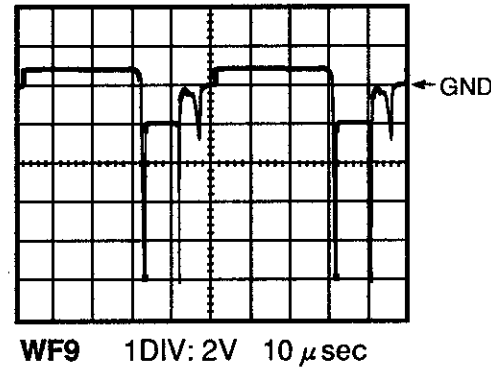
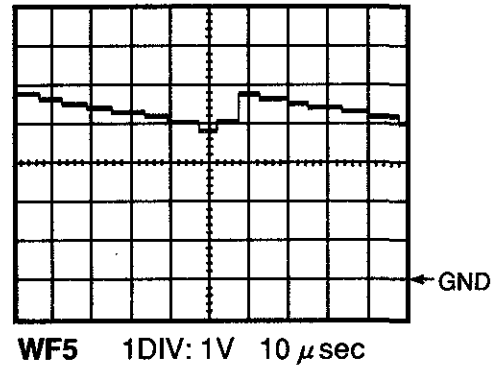
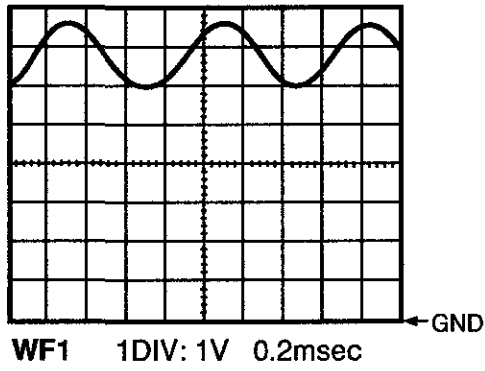

CABINET EXPLODED VIEW

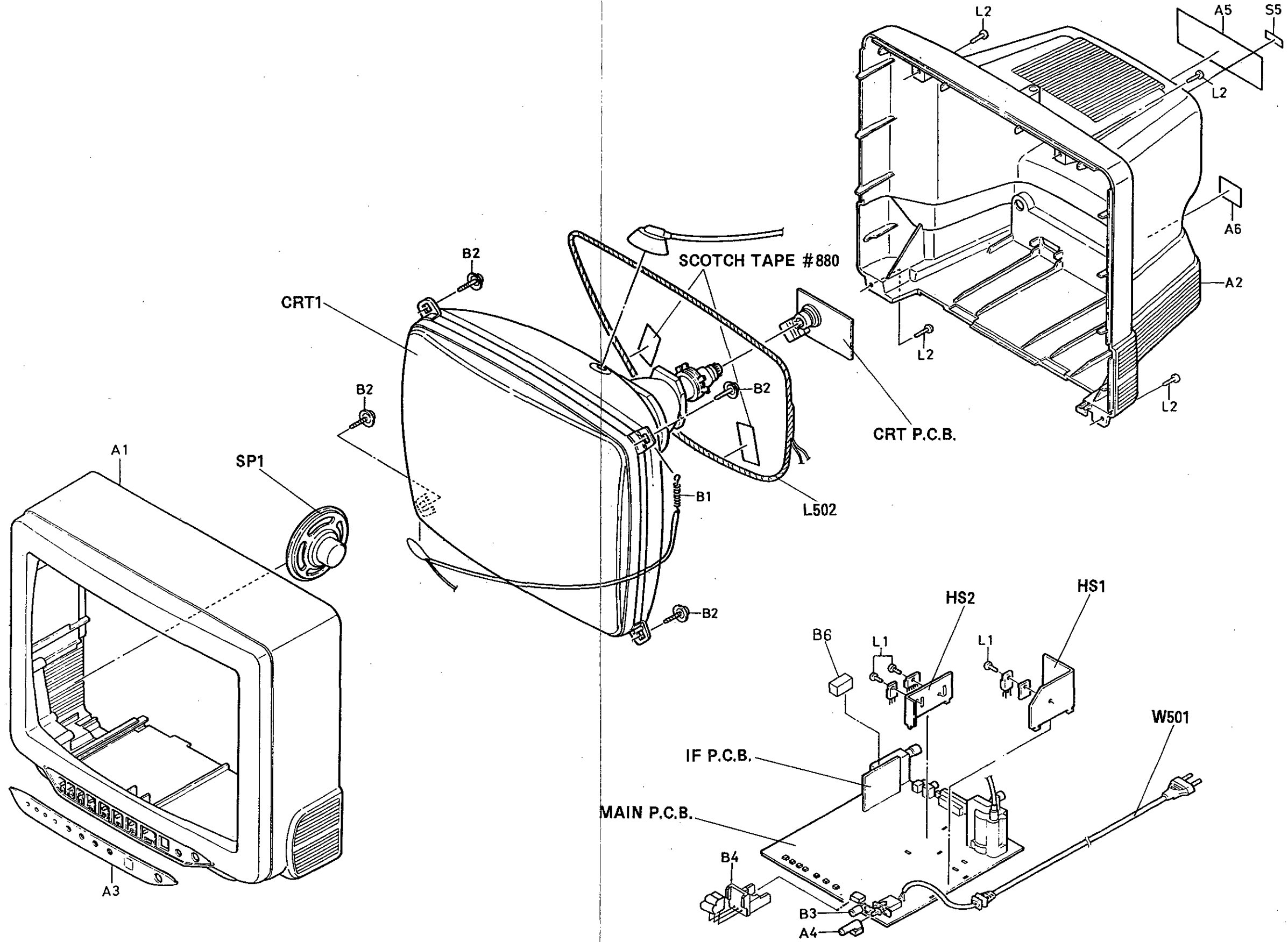

WIRING DIAGRAM

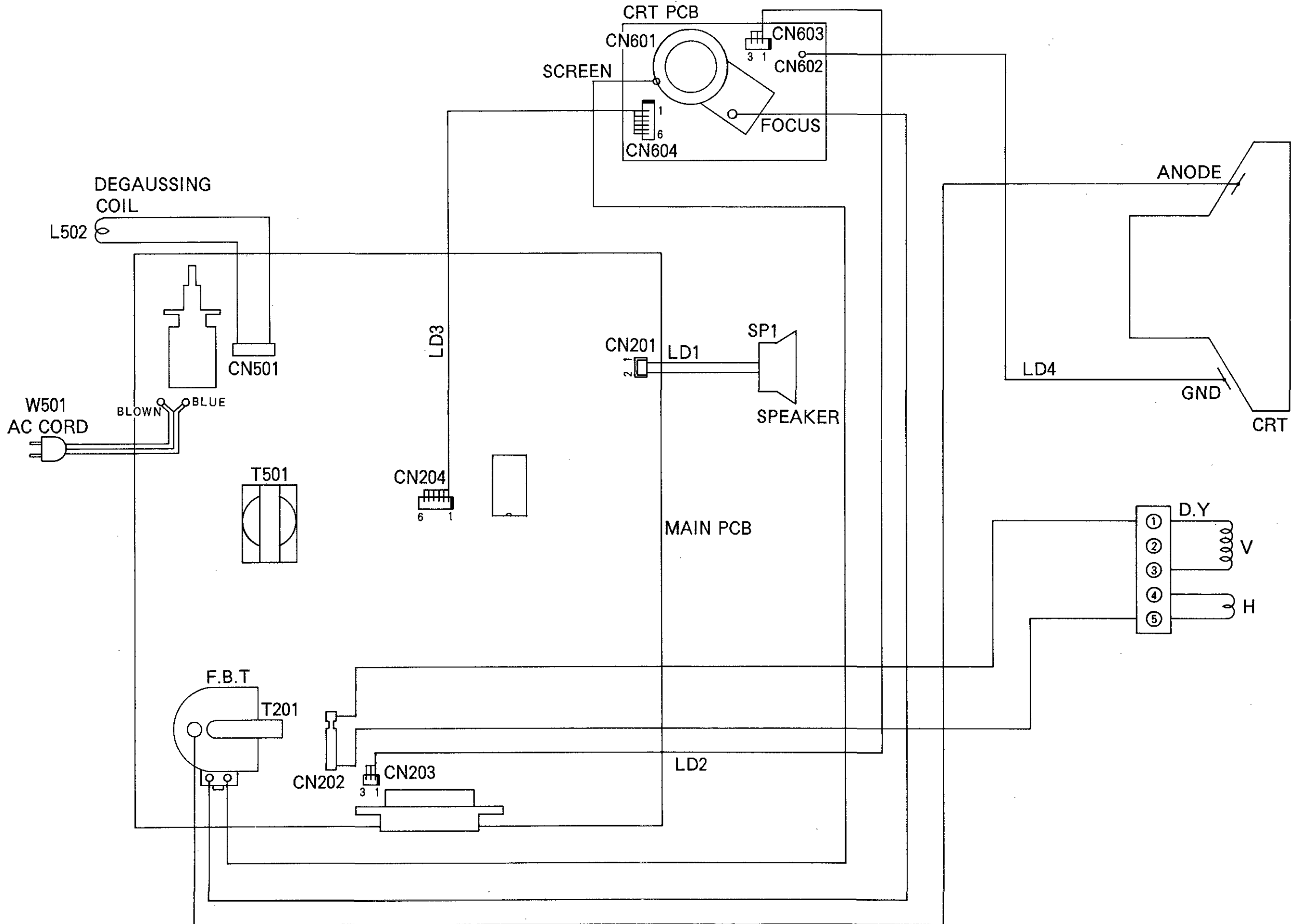

CABINET PARTS LIST

EXPLODED VIEW CABINET PARTS LIST

REF. NO.	PARTS NO.	DESCRIPTION	REMARKS
A1	*9A04115400	FRONT CABINET	
A2	*9A04115500	REAR CABINET	
A3	*9A04115600	CONTROL PANEL	
A4	*9A04115700	KNOB, POWER	
A5	*9A04115800	RATING LABEL	
A6	*9A03805600	SERVICE CONTACT LABEL	
B1	*9A01805800	TENSION SPRING	
B2	*9A01443100	CRT MOUNTING SCREW	
B3	*9A04115900	LED HOLDER	
B4	*9A04116000	SENSOR HOLDER	
B6	*9A04141300	CUSHION	
CRT1	△ 9A01454900	CRT	
HS1	*9A04116700	HEAT SINK, PR	
HS2	*9A04116800	HEAT SINK, PS	
L1	9A02791400	SCREW,B-TIG.BIND HEAD 3*8	
L2	9A04116100	SCREW,P-TIG.BIND HEAD4*18	
L502	△ 9A04116200	COIL, DEGAUSSING	
L502	△ 9A04116300	COIL, DEGAUSSING	
PCB CRT	- - - - -	CRT PCB ASSYSee Electrical List
PCB IF	- - - - -	IF PCB ASSYSee Electrical List
PCB MAIN	- - - - -	MAIN PCB ASSYSee Electrical List
SP1	9A02767200	SPEAKER	
SP1	9A02767400	SPEAKER	
SP1	9A02767300	SPEAKER	
SP1	9A04116600	SPEAKER	
SP1	9A02767100	SPEAKER	
W501	△ 9A04116900	AC CORD	
	*9A04116400	WIER ASSY, (SPEAKER)	
	*9A04116500	WIRE ASSY, (CRT GND)	

PACKING EXPLODED VIEW

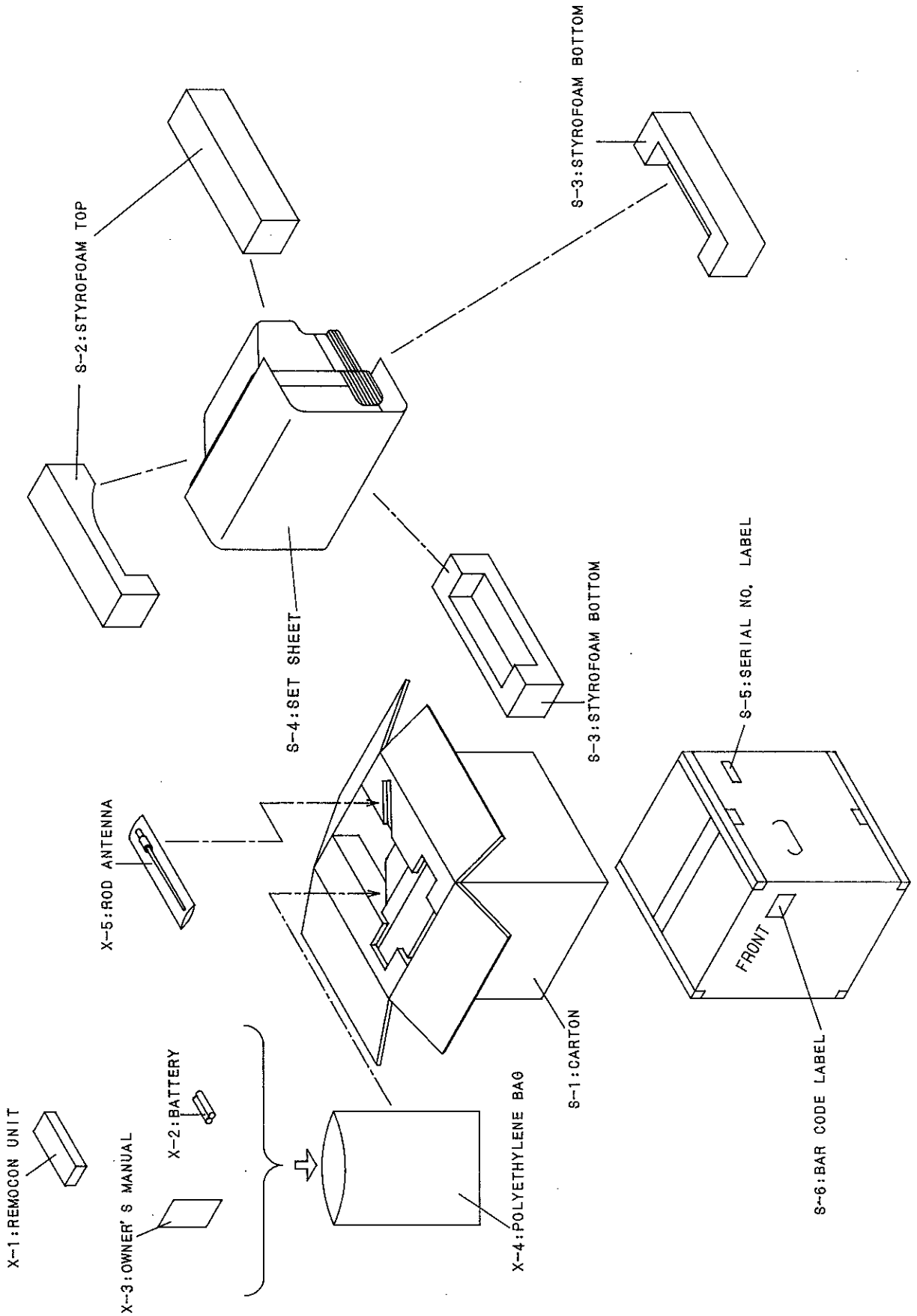

INCLUDED ACCESSORIES & PACKING PARTS LIST

INCLUDED ACCESSORIES & PACKING PARTS LIST

REF. NO.	PARTS NO.	DESCRIPTION	REMARKS
<u>INCLUDED ACCESSORIES SECTION</u>			
X1	*9A04139300	REMOCON UNIT, RC-490	
X2	9A03842500	BATTERY	
X2	9A02343100	BATTERY	
X2	9A04139400	BATTERY	
X3	*9A04139500	OWNER'S MANUAL, (E) CT-M144	
X4	9A03266400	POLY BAG	
X5	9A04139600	ROD ANTENNA	
<u>PACKING SECTION</u>			
S1	9A04139700	CARTON	
S2	9A04139800	STYROFOAM, TOP	
S3	9A04139900	STYROFOAM, BOTTOM	
S4	9A04140000	SET SHEET	
S5	- - - - -	SERIAL NO. LABEL	
S6	- - - - -	BAR CODE LABEL	

CT-M144

TEAC®

TEAC CORPORATION	Musashino Center Bldg.,1-19-18, Nakacho, Musashino-shi, Tokyo 180, Japan	Phone:(0422)52-5081
TEAC AMERICA, INC.	7733 Telegraph Road, Montebello, California 90640	Phone:(213)726-0303
TEAC CANADA LTD.	340 Brunel Road, Mississauga, Ontario L4Z 2C2, Canada	Phone:416-890-8008
TEAC UK LIMITED	5 Marlin House, Marlin Meadow, The Croxley Centre, Watford, Herts. WD1 8YA, U.K.	Phone:0923-819631
TEAC DEUTSCHLAND GmbH	Bahnstrasse 12, 6200 Wiesbaden-Erbenheim, Germany	Phone:0611-71580
TEAC FRANCE S.A.	17, Rue Alexis-de-Tocqueville, CE 005 92182 Antony Cedex, France	Phone:(1)42.37.01.02
TEAC BELGIUM NV/SA	143C Woluwelaan, 1831 Machelen-Diegem, Belgium	Phone:(02)725-6555
TEAC NEDERLAND BV	Perkinsbaan 11, 3439 ND Nieuwegein, Nederland	Phone:03-402-30229
TEAC AUSTRALIA PTY., LTD. A.C.N. 005 408 462	106 Bay Street, Port Melbourne, Victoria 3207, Australia	Phone:(03)646-1733
TEAC ITALIANA S.p.A.	Via C. Cantù 5, Cinisello Balsamo, Milano, Italy	Phone:02-66010500

MAIN / CRT SCHEMATIC DIAGRAM

<NOTE>

- 1.No indicated NPN type transistors are used KTC3199 (GR), 2SC1740S (R, S), 2SC3331 (T, U), 2SC1685 (R, S) or 2SC1815 (GR).
- 2.No indicated PNP type transistors are used KTA1267 (GR), 2SA933S (R, S), 2SA1318 (T, U), 2SA564 (R, S) or 2SA1015 (GR).
- 3.No indicated diodes are used 1SS133 or 1SS176.

CAUTION:
FOR CONTINUED PROTECTION AGAINST FIRE HAZARD,
REPLACE ONLY WITH THE SAME TYPE T4AH 250V FUSE.
ATTENTION: POUR UNE PROTECTION CONTINUE LES RISQUES
D'INCENDIE N'UTILISER QUE DES FUSIBLE DE MEMO TYPE T4AH 250V.
RISK OF FIRE - REPLACE FUSE AS MARKED.

